

*International specialized medium for agricultural mechanization in developing countries*

ISSN 0084-5841

# AMA

**AGRICULTURAL MECHANIZATION IN ASIA, AFRICA AND LATIN AMERICA**

VOL.41, No.1, WINTER 2010

---

**FARM MACHINERY INDUSTRIAL RESEARCH CORP.**

# Appropriate Technology

The quarterly magazine of practical change in the developing world  
Editor: David Dixon

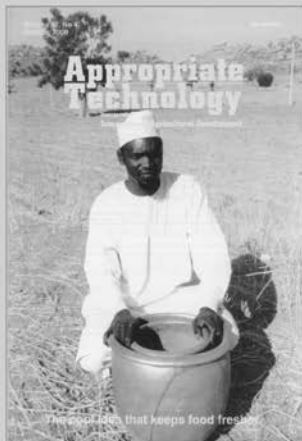

"... so many ideas and methods are adaptable in so many ways ... Thank you for producing such a useful magazine",  
VSO fieldworker, Thailand.

Wherever you live in the world, you will find lots to interest you in *Appropriate Technology*. Concentrating on real-life experiences and problems, the magazine deals with practical development in a clear, straightforward way - and the lessons can be applied in every part of the globe.

Each issue provides practical technologies, policies and ideas addressed to the elimination of poverty and hunger, with articles and case studies giving a full range of viewpoints and perspectives.

*Appropriate Technology* is published quarterly and is sent to subscribers by airmail, at £48 (personal or developing country); £120 (institutions).

Credit card: Visa / Mastercard / American Express

Card No: ...../...../...../.....

Expiry date: .....

Signature: .....

**"If you are working in a developing country and can afford only one journal, this is the one to get", *Appropriate Technology Sourcebook***

View a sample copy on our website:  
[www.appropriate-technology.com](http://www.appropriate-technology.com)

Please complete the form below or use the order form on our website.

- Please invoice me.
- I enclose cheque/money order for .....
- Please charge my credit card, details below left.

Name: .....

Organisation: .....

Address: .....

.....

Tel: .....

Fax: .....

## TWO-WHEEL TRACTOR ENGINEERING for Asian Wet Land Farming

by Jun Sakai

Professor emeritus of Kyushu University, Co-operating Editors of AMA

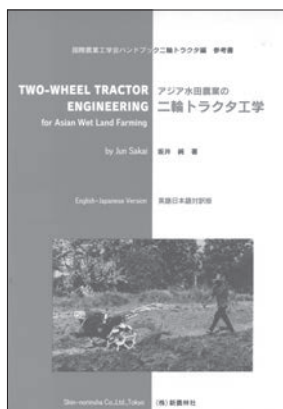

A Present to the students who dream to be an international-minded specialist in farm machinery science & technology.

Introduction of new "Tractor-Tillage Engineering" based on a global view of agricultural civilizations in the world.

Two-wheel tractors contribute to the industrial promotion of agri-countries consisting of small-scale family farms.

The textbook with new guidelines for international technical cooperation with a better mutual understanding.

### CONTENTS

1. Difference between Euro-American and Asian farming civilizations
2. New wheel dynamics and tractor-vehicle engineering in the 21th century
3. New plowing science of walk-behind tractors originated from Asian paddy farming
4. Scientific creation and systematization of rotary tillage engineering in Asia

English - Japanese Version

Price: Japanese

Size: 21cm x 15cm, soft cover, 311 page

**Shin-Norinsha Co., Ltd.**

2-7-22 Kanda Nishikicho, Chiyoda-ku, Tokyo, Japan, Tel: +81-(0)3-3291-3671~4, Fax: +81-(0)3-3291-5717  
E-mail: [ama@shin-norin.co.jp](mailto:ama@shin-norin.co.jp) URL: <http://www.shin-norin.co.jp>

*International specialized medium for agricultural mechanization in developing countries*

ISSN 0084-5841

# AMMA

**AGRICULTURAL MECHANIZATION IN ASIA, AFRICA AND LATIN AMERICA**

VOL. 41, No. 1, WINTER 2010

---

*Edited by*

YOSHISUKE KISHIDA

*Published quarterly by*

Farm Machinery Industrial Research Corp.

*in cooperation with*

The Shin-Norinsha Co., Ltd.

and

The International Farm Mechanization Research Service

TOKYO

**- AFRICA -**

Kayombo, Benedict (Botswana)  
Fonteh, Fru Mathias (Cameroon)  
El Behery, A.A.K. (Egypt)  
El Hossary, A.M. (Egypt)  
Pathak, B.S. (Ethiopia)  
Bani, Richard Jinks (Ghana)  
Djokoto, Israel Kofi (Ghana)  
Some, D. Kimutaiarap (Kenya)  
Houmy, Karim (Morocco)  
Igbeka, Joseph C. (Nigeria)  
Odigboh, E.U. (Nigeria)  
Oni, Kayode C. (Nigeria)  
Kuyembah, N.G. (Sierra Leone)  
Abdoun, Abdien Hassan (Sudan)  
Saeed, Amir Bakheit (Sudan)  
Khatibu, Abdissalam I. (Tanzania)  
Baryeh, Edward A. (Zimbabwe)  
Tembo, Solomon (Zimbabwe)

**- AMERICAS -**

Cetrangolo, Hugo Alfredo (Argentina)  
Naas, Irenilza de Alencar (Brazil)  
Ghaly, Abdelkader E. (Canada)  
Hetz, Edmundo J. (Chile)  
Valenzuela, A.A. (Chile)  
Aguirre, Robert (Colombia)  
Ulloa-Torres, Omar (Costa Rica)  
Magana, S.G. Campos (Mexico)  
Ortiz-Laurel, H. (Mexico)  
Chancellor, William J. (U.S.A.)  
Goyal, Megh Raj (U.S.A.)  
Mahapatra, Ajit K. (U.S.A.)

**- ASIA and OCEANIA -**

Quick, G.R. (Australia)  
Farouk, Shah M. (Bangladesh)  
Hussain, Daulat (Bangladesh)  
Mazed, M.A. (Bangladesh)  
Wangchen, Chetem (Bhutan)  
Wang, Wanjun (China)  
Illangantileke, S. (India)  
Ilyas, S. M. (India)  
Michael, A.M. (India)  
Ojha, T.P. (India)  
Verma, S.R. (India)

Soedjatmiko (Indonesia)

Behrooz-Lar, Mansoor (Iran)

Minaei, Saeid (Iran)

Sakai, Jun (Japan)

Snobar, Bassam A. (Jordan)

Chung, Chang Joo (Korea)

Lee, Chul Choo (Korea)

Bardaie, Muhamad Zohadie (Malaysia)

Pariyar, Madan (Nepal)

Ampratwum, David Boakye (Oman)

Eldin, Eltag Seif (Oman)

Chaudhry, Allah Ditta (Pakistan)

Mughal, A.Q. (Pakistan)

Rehman, Rafiq ur (Pakistan)

Devrajani, Bherular T. (Pakistan)

Abu-Khalaf, Nawaf A. (Palestine)

Nath, Surya (Papua New Guinea)

Lantin, Reynaldo M. (Philippines)

Venturina, Ricardo P. (Philippines)

Al-suhaibani, Saleh Abdulrahman (Saudi Arabia)

Al-Amri, Ali Mufarreh Saleh (Saudi Arabia)

Chang, Sen-Fuh (Taiwan)

Peng, Tieng-song (Taiwan)

Krishnasreni, Suraweth (Thailand)

Phongsupasamit, Surin (Thailand)

Rojanasaroj. C. (Thailand)

Salokhe, Vilas M. (Thailand)

Singh, Gajendra (Thailand)

Pinar, Yunus (Turkey)

Haffar, Imad (United Arab Emirates)

Lang, Pham Van (Viet Nam)

Nguyen Hay (Viet Nam)

Hazza'a, Abdulsamad Abdulmalik (Yemen)

**- EUROPE -**

Kaloyanov, Anastas P. (Bulgaria)

Kic, Pavel (Czech)

Müller, Joachim (Germany)

Pellizzi, Giuseppe (Italy)

Hoogmoed, W.B. (Netherlands)

Pawlak, Jan (Poland)

Marchenko, Oleg S. (Russia)

Kilgour, John (U.K.)

Martinov, Milan (Yugoslavia)

**EDITORIAL STAFF**

(Tel.+81-(0)3-3291-3674)

Yoshisuke Kishida, Chief Editor

Masako Terauchi, Managing Editor

Zachary A. Henry, Editorial Consultant

**ADVERTISING**

(Tel.+81-(0)3-3291-3674)

Yoshito Nakajima, Manager (Head Office)

Advertising Rate: 300 thousand yen per page

**CIRCULATION**

(Tel.+81-(0)3-3291-3674)

(Fax.+81-(0)3-3291-5717)

Editorial, Advertising and Circulation Headquarters

2-7-22, Kanda Nishikicho, Chiyoda-ku, Tokyo 101-0054, Japan

URL: <http://www.shin-norin.co.jp>

E-Mail: [ama@shin-norin.co.jp](mailto:ama@shin-norin.co.jp)

Copyright © 2010 by

FARM MACHINERY INDUSTRIAL RESEARCH CORP.

in SHIN-NORINSHA Co., Ltd

Printed in Japan

## EDITORIAL

Burst of the economic bubble has made the U.S. economy melt down, which escalated into a chain reaction and global economic downturn. Under such difficult conditions, China has still sustained high growth rates and, what is more, China has even alleviated the effects of the economic crisis. If this economic growth keeps up for the next 20 years, in 2030 the per capita national income of China will be the same as that in USA now. It is horrifying to imagine what would happen then. The USA today eats up many resources and, if China in 2030 does the same thing, resources such as paper would drain and might cause extermination of the forests. Regarding the food problem, consumption of meat would get larger and larger, and a huge demand of grain would occur at the same time. This would have a large scale influence on world agricultural trade.

People in all developing countries and rising nations, in addition to China, want to live in prosperity. It is hard to stop that type of hope. However, the earth has reached its limit because of the burst of population and the globalization of economic activities. Humans are born within a life system and must coexist within it to survive on earth. We couldn't live without this system. But, humans have destroyed the system too much. It is in question how to revive this system and how we can be in harmony with it. Especially, the food problem is the biggest of all. The land area per farmer is decreasing every year. To stabilize the supply of safe agricultural products within the limited area of land, we must increase the productivity per unit area. We must also continue to consider environmental safety. This presents a new task for agricultural mechanization. Crop yields must be increased by using agricultural machines appropriately as they perform specific tasks. Also, all intellectual strengths must be utilized to develop agricultural machines with power to perform each task with the least energy consumption. Within the concept of precision agriculture, there are already some machines that are accomplishing this. They can be seen in some agricultural machinery markets today. Taking a long-term view, agricultural mechanization is changing from the development of muscle power to the utilization of intellectual abilities to more efficiently power agricultural machines and operations. I hope this change can be more effectively activated. Many types of large machines exist today that boost production. Intellectual abilities, appropriately applied, can identify machines and methods for increased production that do not require such gigantic machines. The problem of soil compaction would be solved at the same time. Also, a large agricultural field would not be necessary to use small, intellectually designed machines. Small, dispersed types of farming land, or even sloped lands, are not a problem at all for them. One way to harmonize with vital systems is to apply mechanical intelligence to agricultural machines and create a new production system using small, intellectual machines. Of course, this system should be good for the life system.

We must also care about simple, life sustaining, economic food of high nutritional quality for consumption in moderation. In many developed countries, the problem of obesity is raising the cost of healthcare. We should, once again, recognize that not only producing, but also using the limited food appropriately, is one way to solve the food problem. The world is getting smaller, but the gap between rich and poor is getting wider and wider, and so is the technical gap. We must create a new technology for the prosperity of the people in developing nations. If various gaps get wider than they are now in this small world, many people will suffer from stress, and dissension could not be prevented. We must all care about how to press forward with agricultural mechanization in developing nations and provide technical assistance. That is the appointed work of AMA. We truly hope for the readers of AMA to make efforts to achieve their goals.

**Yoshisuke Kishida**  
**Chief Editor**

February, 2010

# CONTENTS

## AGRICULTURAL MECHANIZATION IN ASIA, AFRICA AND LATIN AMERICA

Vol.41, No.1, Winter 2010

<b>Yoshisuke Kishida</b>	7	Editorial
<b>Jagvir Dixit</b>	9	Field Performance and Evaluation of Manual Paddy Transplanter in Kashmir Valley
<b>Alamgir Akhtar Khan Muhammad Arshad Muhammad Yasin Muhammad Rafiq-ur-Rehman</b>	14	Development and Evaluation of a Mobile Sprinkler System for Orchards
<b>Ajay Kumar Verma</b>	20	Modeling for Mechanization Strategies of Rice Cultivation in Chhattisgarh, India
<b>William S. Kisaalita Meghan Shealy, Max J. Neu Philip Jones, Jonathan Dunn</b>	27	Argan Nut Cracker for Southwestern Moroccan Women
<b>K. Kathirvel, S. Thambidurai D. Ramesh, D. Manohar Jesudas</b>	34	Vibration Characteristics of Self Propelled Power Weeders
<b>Jiraporn Benjaphragairat Hai Sakurai, Nobutaka Ito</b>	40	Study of the Mechanics of a 5 HP Power Tiller Attached to a 10-Row Garlic Planter
<b>Hassan Zaki Dizaji, Saeid Minaei Mohammad Reza Y. Taheri</b>	45	Air-jet Seed Knockout Device for Pneumatic Precision Planters
<b>D. K. Vatsa, Sukhbir Singh</b>	51	Sowing Methods with Different Seed Drills for Mechanizing Mountain Farming
<b>Akhir Hamid, Desa Ahmad Ibni Hajar Rukunuddin</b>	55	Performance of Sweet Potato Transplanting Machine on Mineral and Bris Soils
<b>K. P. Singh, Supradip Saha H. N. Mishra</b>	60	Optimization of Machine Parameters of Finger Millet Thresher-Cum-Pearler
<b>Asif B. Shikari, Syed Zameer G. A. Parray, Gul Zafar</b>	68	Evolving Quality Rice for Temperate Highlands
<b>Kunihiro Tokida</b>	72	Estimating Reliability for Redundant Agricultural Machinery Systems
<b>Sandhya, Parm Pal Singh</b>	77	Optimization of Size of Gasholder for Storage of Biogas in Unheated Biogas Plant
<b>A. Derbala, N. Abd El-Kader T. Fouda</b>	83	Effect of Seed Bed Preparation and Fertilization on Soil Water Storage and Barley Production Yield

★  
Co-operating Editor .....91  
Back Issues .....94

★  
★  
Instructions to AMA Contributors .....96

# Field Performance and Evaluation of Manual Paddy Transplanter in Kashmir Valley



by  
Jagvir Dixit  
Associate Professor/ Sr. Scientist  
SKUAST-K, Division of Agricultural Engineering,  
Shalimar, Srinagar-191121 (J & K),  
INDIA  
jagvirdixit@yahoo.com

## Abstract

In Kashmir valley, paddy is transplanted manually using root washed seedling. Suitable technology is needed to reduce drudgery, enhance timeliness of operation and increasing the yield. A 6 row manual paddy transplanter was tested for its feasibility in valley lands. The manual paddy transplanter gave net profit of Rs.1,417 per hectare over manual transplanting. The field capacity of the transplanter was 0.03 ha/h with field efficiency of 67.5 percent. The operation of transplanter revealed that fairly plain land should be maintained to maintain uniform depth. From an ergonomics point of view, the manual paddy transplanter was found a better alternative to manual transplanting due to less drudgery involved.

## Introduction

Rice is the most important and widely grown food grain crop of the Kashmir valley, which accounts 70 % of the total cultivable area. The total production of paddy in the Kashmir region (10 districts) for the year 2001-02 was 75.7 MT in 40.4 m ha area, thus giving the average yield of 1,874 kg/ha (Anon, 2002).

In the region, main paddy growing areas fall under valley lands followed by terraced fields. Valley lands are mild sloppy areas and allow the water to flow from upper to lower side in such a way that there is the continuity of flow from each field. Rice is grown by transplanting of seedlings under puddle field condition. Paddy transplanting often gets delayed due to non availability of labour. Transplanting in the region is done manually, which is tough and involves enormous drudgery and human stress in standing water. It consumes about 250-300 person-h per hectare, which is approximately 25 % of the total labour requirement for rice cultivation (Singh and Hussain, 1983). Non-availability of labour has compounded the situation and paddy transplanting has emerged as the problem in rice growing regions. Optimum plant density and timeliness of operation in paddy is considered essential for optimizing paddy yield which may be possible if dependence on hired labour is minimized. This has set a need for mechanization of transplanting of paddy in the hilly region, also. For a long time, mechanical transplanting using a manual paddy transplanter and self propelled transplanter has been considered the most promising

option because it saves considerable labour, minimizes stress and drudgery, ensures timely transplanting and attains optimum plant density contributing to higher productivity (Behera, 2000).

Several manual and power operated paddy transplanters have been developed (Garg *et. al.*, 1997) and evaluated in the country. However, the equipment has not been evaluated under valley conditions. In order to assess the possibility of mechanization of transplanting operation, a six row manual paddy transplanter (PAU make) was tested for its performance in valley lands and was compared with the manual transplanting method existing in the region.

## Materials and Methods

A six row manual paddy transplanter (PAU make) was performance tested in the valley lands (**Fig. 2**). The machine was comprised of two wooden skids, a main frame assembly made of M.S. pipe that supported the seeding tray made of G.I. sheet, pushing lever, tray indexing mechanism, picker bar assembly and handle. The length and width of the seedling tray was 470 and 205 mm, respectively. The

row-to-row spacing was 200 mm whereas plant to plant spacing could be maintained as per requirement of the specific varieties and region. As the operating handle was pushed down, seedlings from the mats were picked up and transplanted in the puddle field. One person was required to operate the machine in the field. The detailed specifications of the machine are given in **Table 1**.

### Raising Mat Type Seedling

For mechanical transplanting of rice, mat type seedlings and optimum puddle with leveled bed conditions are the two pre-requisites for efficient operation of a transplanter in terms of placement of seedlings. For raising mat type nursery (**Fig. 1**), the frames of MS flats, having 12 compartments of  $400 \times 200 \times 20$  mm. The nursery was near the water source. Soil, sand and FYM were mixed thoroughly in the ratio of 4:2:1. The MS frame was kept over a perforated polythene sheet on leveled field and filled with mixture of soil, sand and FYM up to height of 15 mm in the frame. About 110-120 gm of pre-germinated seeds of paddy variety (K-39 and SKAU-105) were spread evenly in each frame. Then seeds were covered with a thin layer of soil mixture and water was

sprinkled by watering can for proper setting of the soil. The frames were removed after 20 minutes and put up to the next place. The seedbed was mulched with a plastic sheet up to germination of seeds for protection from the birds. The water was applied daily with watering-can for one week and, thereafter, water was applied by flooding the bed. A recommended dose of fertilizer was also given to the nursery. After 28-30 days of sowing, the seedlings came to 3-4 leaf stage and were ready for transplantation.

### Experimental Procedure

For carrying out the field trials, seedlings mats were uprooted and transported to the place of operation of machine on hand cart. The field and nursery conditions at the time of transplanting have been given in **Table 2**. The field experiments were carried out at Wadura and SKUAST-K, Shalimar during kharief 2005-06 and 2006-07. Before transplanting, puddling was done with the help of cultivator. After puddling, the field was planked in order to level it and was left for settlement for one day. On the next day, excess water was drained from the field and 2-3 cm water was maintained to enhance the easy op-

eration of machine and proper fixation of seedlings in the field. Before operating the transplanter in the field, it was tested in laboratory and minor defects were rectified. The operators were trained about the operation of machine in the field. During field evaluation (**Fig. 2**), no major break-down was observed except some minor adjustment in picker bar assembly. The field performance of the transplanter in terms of field capacity, field efficiency, number of hills/m<sup>2</sup>, missed hills, buried hills, floating hills, planting depth, standing angle, time consumed in operation, overall discomfort rating and economic analysis were evaluated by using standard method and compared with manual transplanting. Cost of operation of the transplanter was calculated by assuming its life as 5 years and annual use of 150 hours. The total transplanting cost was determined by using the standard method. The cost of manual transplanting was determined by taking cost of nursery raising and its management, nursery uprooting and transplanting.

To assess the drudgery involved during the transplanting operation, overall discomfort ratings (ODR) of manual paddy transplanter was studied. The trials of 30 minute

**Fig. 1** Mat type nursery raising



**Fig. 2** Rear and front view of manual paddy transplanter in operation





duration were conducted and each trial was replicated thrice with each subjects. Overall discomfort rating was assessed using a 10-point visual analogue discomfort (VAD) scale where 0 was anchored as no discomfort and 10 as extreme discomfort. The ODR given by each of three operators were added and averaged to get the mean rating. Similarly, overall discomfort ratings of three persons were assessed during hand transplanting of paddy.

## Results and Discussions

### Operation of the Transplanter

The transplanting operation was generally found satisfactory by the transplanter. The average field capacity of the transplanter was 0.03 ha/h with field efficiency of 67.5 percent (Table 3). The turning time loss was estimated as 9.75 % due

to small field size. Nursery feeding consumed about 7.5 % of total time of operation. Clogging of transplanting fingers with seedling a few times was also observed because of buckling of mat at the base of the tray. Seedlings grown in the frames over polythene sheet got their roots entangled forming a root mat. About 6.3 % missing hills were observed at the time of transplanting due to various factors like non-release of seedlings from fingers due to loose soil and non-picking of seedlings by finger; however, there was no burying of the hills with the transplanter. Some floating hills were observed at the place where the standing water level was more than 40 mm. The transplanter could successfully transplant paddy seedlings at 200 mm row to row spacing and 100-125 mm plant to plant with 2-5 plants/hill. The hills fixed by transplanter stood at an angle of 65 to 75 de-

grees, which became straight after one week of transplanting.

### Economics of Operation

The economics analysis showed that the cost of operation of the transplanter was Rs.25.51 per hour by considering 150 hours of annual use (Table 4). Taking into account the average field capacity of the transplanter, the cost of transplanting of one hectare area was Rs. 1,759. The above estimated cost involved were those for nursery raising, its management, uprooting, transportation, feeding and operating cost of the transplanter. The cost of hand transplanting was estimated as Rs.3,176 per hectare with a labour requirement of 363 man-h/ha. Thus, a net profit of Rs.1,417 per hectare would be realized over the hand transplanting.

It is pertinent from Table 5 that effective tillers were more in mechanical transplanting (15.2/ tillers/hill) as compared to hand transplanting (14.9 tillers/hill). This might be due to maintenance of uniform and optimum spacing between row to row and plant to plant. Also, during hand transplanting,

**Table 1** Technical specifications of manual paddy transplanter

Particulars	Specifications
Make	PAU
Dimensions (l × w × h), mm	1030 × 1470 × 930
Weight, kg	20
Adaptable seedlings	Mat type
Row to row spacing, mm	200
Number of rows	6
Plant to plant spacing, mm	As per requirement
Type of float	Wooden skid
Type of fingers	V- notch type
Max. depth of finger entering the mat, mm	1.5
Planting depth, mm	20-40
Cost of machine, Rs	4,000

**Table 2** Field and nursery conditions at the time of transplanting

Particulars	Year 2005-06	Year 2006-07
Type of nursery	Mat Type	Mat type
Variety of rice	K-39	SKAU-105
Seed rate/mat, g	120	110
Age of seedlings, days	30	28
Plant density, no/cm <sup>2</sup>	4	5
Height of seedling, mm	130-140	135-140
Leaf stage	4	3-4
Root length, mm	25-30	30-35
Depth of puddling, mm	120-130	125-135
Standing water level, mm	15-20	20-30

**Table 3** Field evaluation of manual paddy transplanter

Attribute	Year 2005-06	Year 2006-07
Rowspacing, mm	200	200
Planting distance, mm	100-120	110-125
Planting depth, mm	25-30	30-35
No of seedlings/ hill	2-4	4-5
Standing angle of transplanted seedlings, degree	-	65-75
Missed hills, %	7.0	5.6
Floating hills, %	0.05	1.00
Buried hills, %	Nil	Nil
Area uncovered, %	3.5	4.5
Field capacity, ha/h	0.025	0.030
Field efficiency, %	66	69
Percent distribution of operating time		
a. Transplanting time	79.20	81.80
b. Total time loss	20.80	19.20
i. Turning loss	9.30	10.20
ii. Mat feeding	8.25	6.80
iii. Adjustment/ repair	3.25	2.20
Labour requirement, man-h/ha	80	67

the root washed seedlings get shock before establishment in the puddled soil while in mat seedling, the roots were carrying some soil within the root-net and seedlings being mechanically detached in clusters from the mat had more uniform placement in the puddle soil. The average yields of crop was 4,510 kg/ha for mechanical transplanting compared to that of 4,810 kg/ha for hand transplanting (Fig. 3). The lower yield with manual transplanter might be due to missed hills (6.3 %) and untransplanted area left (4.0 %) during turning of the transplanter.

### Postural Discomfort

The average overall discomfort rating on a 10-point visual analogue discomfort scale for mechanical transplanting was 7.6 for an operating duration of 45 min in comparison to 8.1 for hand transplanting (Table 5). The data indicated high level of workload on the transplanter operator due to movement in standing water conditions. But, the operation of the manual transplanter was less tiring in comparison to hand transplanting. From ergonomical point of view, manual paddy transplanter was a more viable source for paddy transplanting than hand

transplanting. The high overall discomfort score in hand transplanting was mainly due to bending posture of persons during transplanting of paddy.

### Conclusion

The use of 6-row manual paddy transplanter in Kashmir valley revealed that

The net profit of Rs.1,417 per hectare by the use of manual paddy transplanter over the manual

transplanting was estimated.

The operation of 6-row manual paddy transplanter was satisfactory in the fields and its field capacity was 0.03 ha/h with field efficiency of 67.5 percent.

To check floating hills, fairly plain land was required to maintain uniform depth of standing water.

To reduce missing hills, development of hard pan in the fields and application of lubricants on the tray was necessary.

The performance of the trans-

**Fig. 3** Cost involvement in transplantation and grain yield

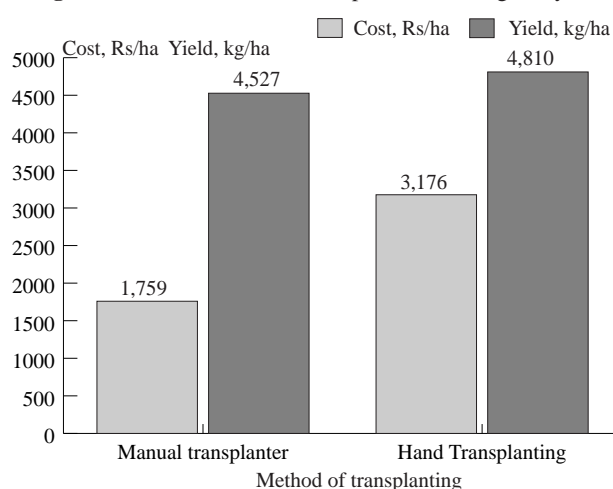

Assumed: labor cost: Rs.70/day, Operator cost: Rs.150/ day

**Table 4** Cost of transplanting by the transplanter and manual transplanting

Activity	Man-h/ha	Cost, Rs/ha
Cost of operation of transplanter		
i. Fixed cost	-	260.6
ii. Variable cost	-	625.0
iii. Cost of nursery raising		
a. Cost of polythene	-	200.0
b. Nursery raising & management	48	420.0
© Mat cutting & feeding	29	253.7
<b>Total cost of transplanting by transplanter</b>	-	<b>1,759.3</b>
Cost of manual transplanting		
i. Nursery raising & management	35	306.2
ii. Nursery uprooting	108	945.0
iii. Transplanting	220	1,925.0
<b>Total cost of manual transplanting</b>	<b>363</b>	<b>3,176.2</b>

**Table 5** Comparative performance of manual paddy transplanter with hand transplanting

Attribute	Manual paddy transplanter	Hand transplanting
Method of nursery raising	Mat type	Root wash
Row spacing, mm	200	125-150
Plant to plant spacing, mm	100-125	100-105
No of seedlings/ hill	2-5	5-6
Planting depth, mm	25-35	30-35
No. of plant/m <sup>2</sup>	36-40	40-45
Field capacity, ha/h	0.030	0.004
Labour requirement, man-h/ha	73	220
Effective tillers/ plant (hill)	15.2	14.9
Grain yield, kg/ha	4,527	4,810
Overall discomfort rating on 10 point VAD scale	7.6	8.1

planter in terms of seedlings placement depended solely on the quality of nursery. The root mat seedlings had to be of specific density and height. From an ergonomics point of view, the transplanter caused less drudgery as compared to hand transplanting.

## REFERENCES

Anonymous, 2002. Digest of Statistics, Directorate of Economics & Statistics Planning & Development Department. Government of J & K.  
Behera, B. K. 2000. Investigation on puddle soil characteristics in relation to performance of self propelled rice transplanter. Ph.D

Thesis G.B. Pant University of Ag. & Tech., Pantnagar. pp 197.  
Garg. I. K, V. K. Sharma, J. and S. Mahal. 1997. Development and field evaluation of manually operated six row. 28(4): 21-24.  
Singh, G. and U. K. Hussain. 1983. Modification and testing of a manual rice transplanter. AMA. 14(2): 25-30.

■ ■

---

## NEWS

---

### **CIGR World Congresses and International Conferences, 2010-2014**

- **The XVII CIGR World Congress 2010**  
Québec, Canada, 13-17 June 2010  
<http://www.cigr2010.ca>
- **CIGR-AgEng2012, International Conferenced of Agricultural Engineering on 'Agricultural & Engineering for a Healthier Life'**  
Valencia, Spain 8-12 July 2012  
<http://www.ageng2012.org>  
*Scope of the CIGR-AgEng 2012 Conference in Valencia*
- **The XVIII CIGR World Congress 2014 on Agricultural & Biosystems Engineering - Upgrading Our Quality of Life**  
Beijing, China, 16-19 September 2014

# Development and Evaluation of a Mobile Sprinkler System for Orchards



by  
Alamgir Akhtar Khan  
Assistant Agricultural Engineer  
Agricultural Mechanization  
Research Institute (AMRI),  
Multan,  
PAKISTAN

Muhammad Arshad  
Associate Professor  
Irrigation & Drainage,  
University of Agriculture,  
Faisalabad,  
PAKISTAN



Muhammad Yasin  
Director  
Agricultural Mechanization  
Research Institute (AMRI),  
Multan,  
PAKISTAN



Muhammad Rafiq-ur-Rehman  
Director General  
Agriculture (Field),  
Punjab, Lahore,  
PAKISTAN

## Abstract

A mobile water spraying system using a rain gun was developed and tested in the citrus orchard of the University of Agriculture, Faisalabad. Guidelines were developed for researchers/farmers to make decisions with respect to the amount of water that should be sprayed for the temperature to be reduced to the desired level. Preliminary testing of the mobile sprinkler system reduced the tree canopy temperature from 45 °C to 30 °C by spraying water at 300 L/min for about 13 min. Temperature of the tree canopy, wind velocity and relative humidity were taken as variables of the mathematical model.

## Introduction

Citrus fruit production ranks second after grapes in the world. Citrus is the best fruit of Pakistan and holds number the one posi-

tion among all fruits. According to Agricultural Statistics of Pakistan (2004-05) citrus was grown on an area of 183,800 hectare with a production of 1,943,600 tons. About 73 million tons of citrus are produced annually in all parts of the tropical world with Brazil being the leading citrus producing and exporting country. Pakistan is in the top ten of the world citrus producing countries with negligible export. The challenge is to capture a share of the world trade in order to earn foreign exchange.

The total cultivated area in Pakistan under citrus crops is about 2.28 % compared to about 20 % for the USA. There are approximately 215,000 orchards in the country, 96 % of which are between 0.5 to 5 hectares covering 66 % of the total orchard area, whereas 30 % of the orchards have an area more than 20 ha. More than 65 % of the total fruit and 95 % of citrus production is concentrated in the Punjab province (Mahmood, 1994).

Rainfall in Pakistan is neither sufficient nor regular. The highest rainfall occurs during the monsoon month of July and a small portion of the country receives 380-1,270 mm that occurs during the summer season. In southern Punjab, Sindh and a large portion of Western Baluchistan, the annual rainfall is between 130-200 mm. The humidity is very low during the months of April, May and June. An important seasonal characteristic is that evaporation is much more than precipitation making frequent artificial water spraying essential for some fruit plants.

The average yield of citrus fruit in Pakistan is 9.2 tons/ha which is very low as compared to other countries like USA and Brazil that have a yield of 20 to 30 tons/ha. Among other reasons for low yield of citrus in Pakistan, dropping of immature citrus fruit due to abrupt rise of environmental temperature during May and June is the most significant reason. It is reported that application

of water to citrus trees in the form of spray during the tough hot season could reduce dropping of fruit, increase yield and improve flavour and size. Among the reasons for poor fruit yield of Kinno and Litchi in Pakistan, the abrupt increase in temperature has been found responsible to a considerable extent. After the middle of May, and in some years even in April, atmospheric temperature rises abruptly. This rise of temperature causes dropping of immature citrus fruit, which has been reported to be one of the major reasons for low yields.

Raschke (1960) reported that the environmental factors that minimize the effect of drought on productivity include plant part temperature and plant water status that are the interrelated. The temperature of any particular plant part is an integrated result of both environmental and plant factors.

Mendal (1969) concluded that the important citrus temperature for growth is 12.5-13 °C minimum, 23-30 °C optimum and 37-39 °C maximum.

Water sprinklers were used as environment modifiers for orchards by Christiansen (1942) who concluded that a sprinkling system was satisfactory when the co-efficient of uniformity was within the range of 60 to 90 %.

Chessness *et al.* (1978) summarized the results of several studies and concluded that leaf temperature reduction was up to 10 °C with water sprinklers.

Norman (1982) stated that another possible benefit of keeping the leaf surface wet was a reduction in transpiration demand. He further reported that on very hot, dry, windy day when the transpiration demand was high enough to cause water stress in well-watered plants, the wetting of the leaf surface reduced the transpiration demand.

Toile (1982) reported that intermittent sprinkling of water had a potentially beneficial effect on the

plant by cooling the soil surface. That cooling further resulted in lowered radiation load on the plants. Water application time to reduce the heat stress on a citrus orchard was a function of wind velocity, relative humidity, canopy temperature and temperature of applied water. Wind velocity played a vital role on uniformity of water distribution, evaporation, humidity and temperature of the tree canopy. Relative humidity was defined as the ratio of weight of water vapor per unit volume of air to the weight of water vapour in unit volume of saturated air at the same temperature.

Therefore, it was planned to develop a low cost water spraying system to modify the citrus orchard environment. Since overhead sprinkler systems being used in developed countries are very expensive, use of a rain gun sprinkler system powered with a high speed diesel engine or through tractor PTO could be a cheaper alternate to spraying water on orchards in the required quantity. Efforts have been made to provide guidelines for the farmers to make decision regarding how much water they should spray to bring the temperature down to a desired level

through a mathematical and graphical prediction method. The objectives of the study were as follows:

- i. To develop a mobile sprinkler system to reduce heat stress in citrus orchards.
- ii. To develop a mathematical relationship to predict duration of spray when environmental parameters are known.
- iii. To formulate recommendations and guidelines for suitable operational parameters of a sprinkler system for orchards.

## Materials & Methods

A commercially available rain gun system was mounted on a trolley. The system was comprised of a pressure pump with a discharge 6.67 L/s, a high speed 14 kW diesel engine and a rain gun with a flow rate 25.2 m<sup>3</sup>/h at 3.5 kg/cm<sup>2</sup> pressure. The nozzle diameter was 1.8 cm with a range of 39 m and application intensity of 5 mm/hr with elevation control as shown in the Fig. 1. Overall dimensions of the system were 225 cm high, 143 cm wide, 220 cm long with provision for a 25

Fig. 1 Mobile water spraying system

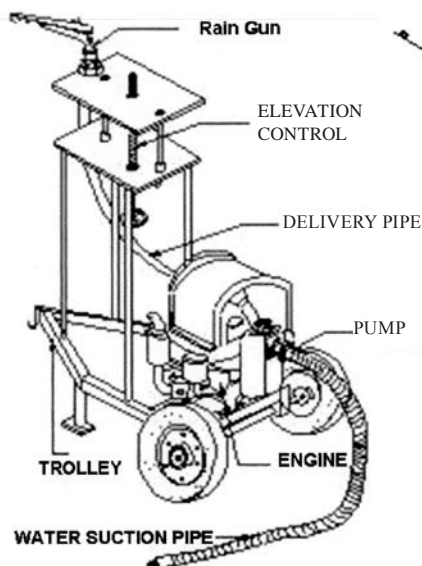
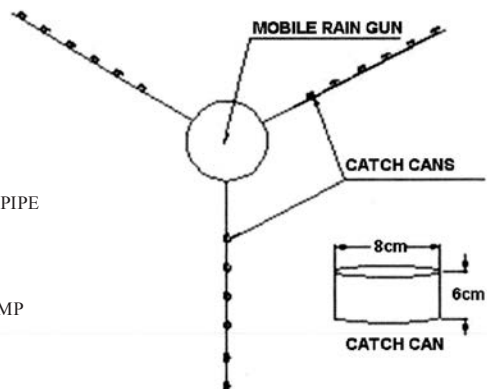

Fig. 2 Arrangement of catch cans in the field



cm increase in height.

The test of the system in a citrus orchard showed that the application time to reduce the heat stress was a function of wind velocity, relative humidity (RH), tree canopy temperature and temperature of applied water. The effect of each parameter on application time is discussed below.

The system was tested in a citrus orchard of the University of Agriculture, Faisalabad. Co-efficient of uniformity was checked by placing catch cans 8 cm diameter and 6 cm high at 1 m interval in 3 lines 120° apart from one another. **Fig. 2** shows the arrangement of catch cans in the field. The system was operated with a pump pressure of 3.5 kg/cm<sup>2</sup>. After 18 minutes of water application, the volume was measured with a graduated cylinder. The volume of water caught was divided by the cross sectional area of the catch can/cup to calculate the depth of catch. This was used to determine the co-efficient of uniformity using the procedure developed by James (1998) as explained below:

$$C_u = 100 - 80xs / x,$$

where

$C_u$  = Co-efficient of uniformity, %,

$s$  = Standard deviation of the observations and

$x$  = average depth of water stored.

Observations were recorded for ten different days at noon between 12 and 14.50 hours. Wind velocity played a vital role on uniformity of water distribution, rate of evaporation, humidity and temperature of tree canopy. A digital anemometer was used to measure the wind velocity. Average tree height in the orchard was 410 cm. Wind velocity at an elevation equivalent to the middle of the tree was expected to affect the other parameters. Therefore, the impeller of the anemometer was placed slightly above the middle of the tree canopy at about 270 cm above the ground in an open place within the orchard to note the actual wind velocity at that height.

During the operation of the rain gun in the citrus orchard, three readings of wind velocity were recorded and the mean value used for the development of the prediction eqn..

Relative humidity is one of the important parameters to be considered in estimation of water application time. This parameter was given due importance and was checked and recorded before testing. Change in relative humidity was observed in the citrus orchard before and after the operation of the rain-gun by using a wet and dry bulb thermometer. A hygrometer was installed in the air at a distance of 15 m from the rain-gun (almost in the middle of the effective radius). The trend of decrease of humidity in the orchard after water application was also recorded.

Temperature of the tree canopy was the most important parameter to be considered in the entire study. According to the literature review, air temperature higher than 37 °C causes heat stress in the citrus tree. A thermometer was installed in a citrus tree about 15 m from the rain gun and was properly shielded to

avoid direct contact of applied water. Temperature of the tree canopy was recorded before and after water application at one minute intervals to note the trend of decrease of tree canopy temperature with water application and its increase after stoppage of the rain gun.

Temperature of applied water could play a dominant role on reducing air temperature within the orchard. This temperature was measured by using a digital thermocouple. Water temperature remained the same during all the observations in the orchard. Therefore, its effect on time of application could not be analyzed.

## Results and Discussion

Christianson co-efficient of uniformity ( $C_u$ ) was 82.03 % at 3.50 kg/cm<sup>2</sup> pump pressure. **Fig. 3** shows the water distribution profile for the rain gun with a circular nozzle. The wind velocity at about 270 cm above the ground ranged between 0.58 m/sec to 2.5 m/sec. **Table 1** shows the effect of wind velocity

**Table 1** Parameter related with application time prediction eqn.

Time to reduce temperature up to 30 °C min (T)	Temperature of tree canopy °C ( $C_T$ )	Wind velocity, m/s ( $V_w$ )	Relative humidity, % (RH)	Temp. of applied water (°C)
11	39.5	0.61	61	30
10	41.0	0.91	24	30
11	41.0	0.77	29	30
9	38.5	0.78	30	30
11	42.0	0.90	29	30
12	44.0	0.97	24	30
8	42.0	2.50	22	30
12	42.0	0.58	25	30
10	40.0	0.98	27	30
13	45.0	0.92	26	30

**Table 2** Coefficients of regression

Predictor	Coef	Std-Dev	T-Ratio
Constt.	-13.386	5.226	-2.56
CT	0.6008	0.08676	9.93
WV	-1.9592	0.3362	-5.83
RH	0.04126	0.07916	0.52

$S = 0.4203$ ,  $R - sq = 94.7\%$

**Fig. 3** Water distribution profile for circular nozzle

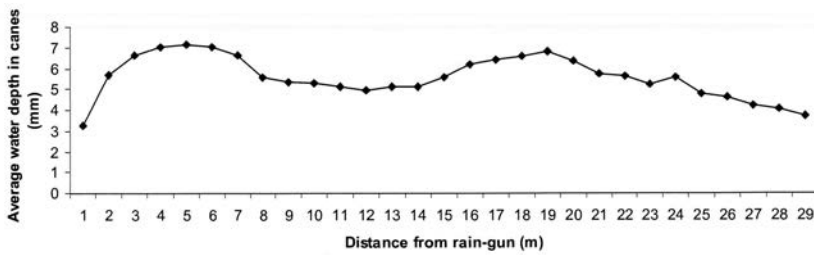

**Fig. 4** Trend of change in relative humidity with water application at 0.61 m/s wind velocity

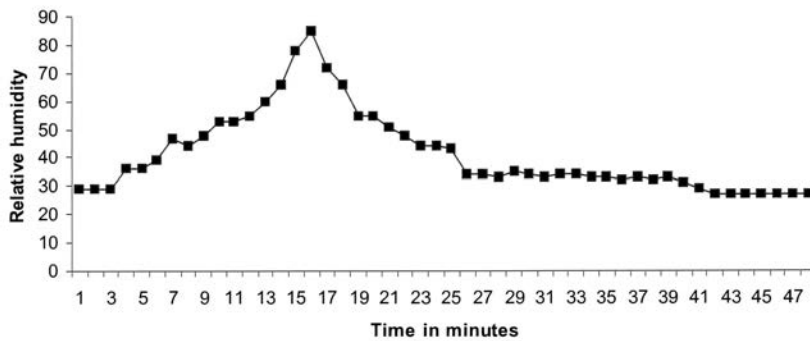

**Fig. 5** Trend of change in relative humidity with water application at 0.91 m/s wind velocity

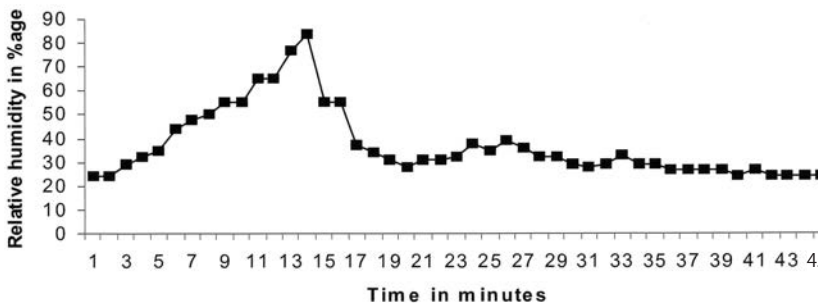

**Fig. 6** Trend of change in relative humidity with water application at 0.77 m/s wind velocity

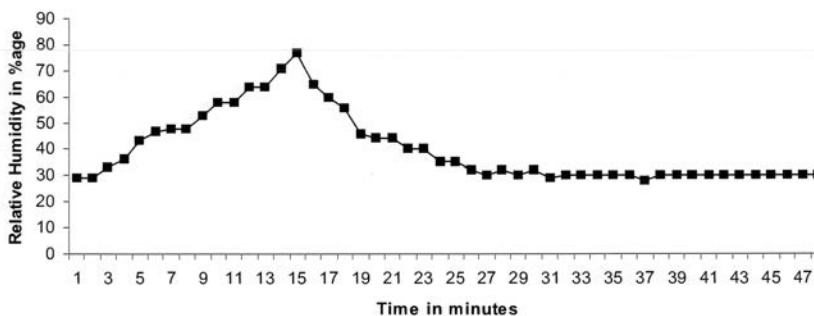

upon water application time, which reduced with high wind velocity. **Table 1** also shows that the value of relative humidity in reference to the parameters is quite unexpected, most probably it depends upon the rainfall in the surroundings and temperature peaks. The relative humidity ranged between 22 % to 30 % during the days of the experiment. **Figs. 4, 5** and **6** show the change in relative humidity with water application time at 0.61 m/s, 0.91 m/s and 0.77 m/s wind velocity. The trend remained similar during all observations.

The temperature range, shown in the **Table 1**, was 38.5 °C to 45 °C, which sometimes dropped to 27 °C within 8 to 13 minutes of water application. **Figs. 7, 8** and **9** show the trend of change in tree canopy temperature with water application time and also revealed that temperature of the tree canopy decreased even below the temperature of applied water, which was 30 °C. This might be due to the effect of evaporation of water droplets within the air as well as to splash as a result of impact of water droplets on the tree.

No variation in canal water temperature was observed when air temperature rose up to 45 °C. The water temperature during test applications remained about 30 °C.

Analysis of the above data was made using Minitab computer software to develop a regression eqn. to predict time of application of water to bring the canopy temperature to 30 °C when ambient temperature, wind velocity and relative humidity, before water application, were known. The statistical data analysis is presented in the **Table 2**.

$$T = -13.4 + 0.601 C_T - 1.96V_w + 0.0413RH \dots \dots \dots (1)$$

This shows that regression **Eqn. 1** could be trusted within the observed range of data. This eqn. was evaluated by putting the observed values of the independent variable in the eqn. and comparing these with that of observed and predicted values for

**Fig. 7** Trend of change in tree canopy temperature with water application at 0.61 m/s wind velocity

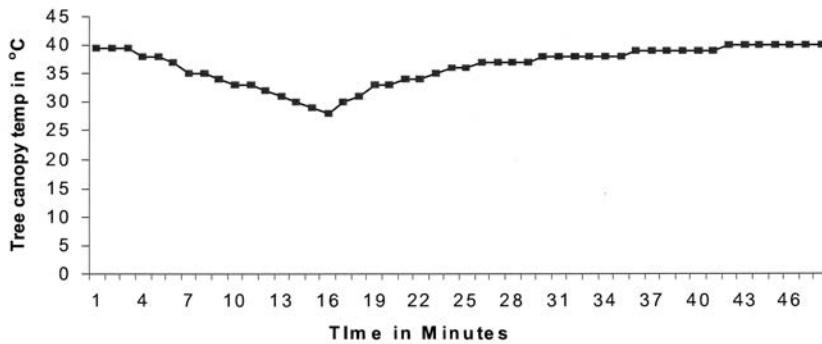

**Fig. 8** Trend of change in relative humidity with water application at 0.78 m/s wind velocity

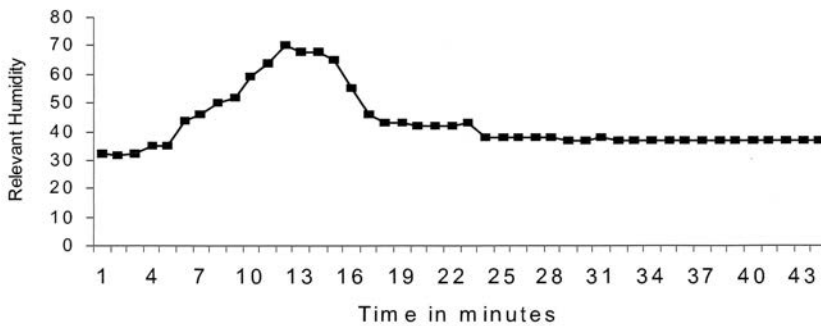

**Fig. 9** Trend of change in tree canopy temperature with water application at 0.91 m/s wind velocity

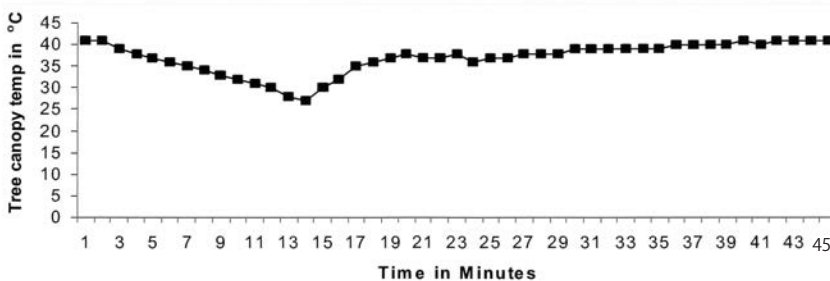

**Fig. 10** Comparison of observed and predicted values of time

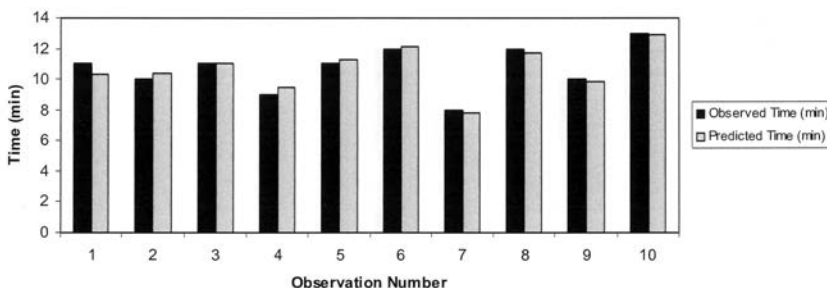

application time to reduce the temperature (T) up to 30 °C.

The data for observed and predicted values are given in the **Table 3**. **Fig. 10** shows a bar graph of observed and predicted values of time required for spraying water to reduce the temperature of the tree canopy. The deviation of the predicted values from the observed values of water application time was not very significant.

## Summary

A water spraying system with a circular nozzle was tested in a citrus orchard and data were collected for the development of a mathematical relationship to predict the required duration of spray. The system was tested in a citrus orchard for ten days. Co-efficient of uniformity of the nozzle was 82.03 % and was satisfactory as it fell within acceptable range, which was 60 to 90 %. During testing, wind velocity remained within 0.58 to 2.5 m/s, relative humidity remained within 22 to 30 % and tree canopy temperature was 38.5 °C to 42 °C. Canal water running in a watercourse was used and its temperature remained almost constant at 30 °C. A regression eqn. was developed and tested. The predicted and observed results were very close.

**Table 3** Observed & predicted values of time to reduce temperature

Observed time, min	Predicted time, min
11	10.34
10	10.44
11	10.99
9	9.45
11	11.27
12	12.13
8	7.85
12	11.73
10	9.83
13	19.92



## REFERENCES

- Meyer, L. D. 1958. An investigation of methods for simulating rainfall on Standard runoff plots and a study of the drop size, velocity and kinetic energy of selected spray nozzles. Special Rtd. No. 81 USDA-ARS.
- Moss G. I. 1973. Major factors influencing flower formation and subsequent fruit setting of sweet orange. *Congreso Mundial De Citricultura*, 2: 215-222.
- Norman, J. M. 1979. Modeling the complete crop canopy. *Modification of the Aerial Environment of Crops*. ASAE Monogr. 2, American Society of Agri. Engineers, St. Joseph, MI, pp. 249-277.
- Norman, J. M. 1982. *Simulation of microclimates*. Biometeorology: Integrated Pest Management. Academic Press, New York, NY, pp. 65-00.
- Nurnberger, F. V., G. E. Merva, and J. B. Harrington. 1976. Micro-mental modification by small water droplet evaporation. *J. Applied Meteorol.* 15: 858-867.
- Raschke, K. 1960. Heat Transfer between the plants and the environment, *Annu. Rev. Plant Physiol.*, 11: 111-126.
- Rosenberg, N. J. 1979. Windbreaks for reducing moisture stress. *Modification of the Aerial Environment of Crops*. ASAE Monogr. 2, American Society of Agricultural Engineers, St. Joseph, MI, pp. 394-408.
- Sarwar Yaqub and Iqrar Ahmad. 1996. Breeding for seedless citrus Interploid hybridization in vitro callus induction from endosperm and evaluation of different citrus triploids. M.Sc. Thesis University of Agriculture, Faisalabad, Pakistan.
- Shafiq Anwar and Arshad Ali. 1995. Feasibility study of using rain-gun sprinkler under irrigated areas. M.Sc. Thesis University of Agriculture, Faisalabad, Pakistan.
- Shull, H. and A. S. Dylla. 1976. Wind Effects on Water Application Patterns from a large single nozzle sprinkler. *Trans. ASAE*, Jan: 501-504.
- Sinclair, W. 1984. The biochemistry and physiology of the lemon and other citrus fruit. University of California, Division of Agriculture and Natural resources.
- Sardo, V. and Germana. 1990. Mist irrigation for environmental control and its effect on orange trees. *Acta Horticulturae* 278: 553-562. ■■

# Modeling for Mechanization Strategies of Rice Cultivation in Chhattisgarh, India



by  
Ajay Kumar Verma  
Associate Professor  
Faculty of Agricultural Engineering,  
Indira Gandhi Agricultural University,  
Raipur, (C.G.),  
INDIA  
ajayaverma@rediffmail.com

## Abstract

The scarcity of water is a critical limitation for sustainable productivity of rainfed rice in Chhattisgarh State of India. Amongst the available, possible alternatives to overcome the problem of unsustainable rice yield, direct row seeded rice cultivation was more promising to sustain water scarcity during dry spells. This research identified information on machinery inventory and utilization and the source wise energy use pattern for various operations in rainfed rice cultivation. It was predicted that, by the use of mechanical power, seedbed preparation and sowing operation might be completed before onset of monsoon. Timeliness of sowing of rice crop could utilize every unit of rain in the growing season. According to available resources, the developed model makes suggestions for decisions relating to the adoption of rice crop establishment technique.

## Introduction

Chhattisgarh State of India comes under dry and sub humid climate. It is an area of small and marginal farmers. The success or failure in rice production is directly related

to the economy of the farmers of this category. Rice is a labour and water intensive crop. Fujisaka (1991) emphasized that Biasi (Beusani) is a common crop establishment practice in rainfed lowland rice areas of eastern India. Biasi is used in dry seeded lowland fields to control weeds. But Biasi reduces not only the weed population, but also the rice plant population. Jacobi (1974) conducted studies on tillage for low land rice in Orissa and noticed that rainfall pattern is one of the important problems for timeliness of the soil tillage operation. Gupta *et al.* (1992) reported that drill seeding in dry soil makes the mechanical seed drill feasible. It improves soil structure since puddling is minimized. Lower labour cost is the major advantage of direct seeding. The method eliminates seedbed preparation, care of seedlings in the seedbed, pulling seedlings and hauling and transplanting operations. The savings in labour may substantially reduce production cost, particularly in areas where labour cost is high. Also, direct seeded rice may mature 7-10 days earlier than transplanted rice. This saving in time is important, especially where multiple cropping patterns are used. Verma *et al.* (2002) conducted studies on a row seeding implement. It was found

that yields of row seeded rice (3-3.5 t/ha) were more as compared to broadcast seeded rice (2.4-2.7 t/ha).

Seedlings are first grown in the seedbed for transplanting before they are planted in the puddled field. Physiologically, proper age of seedlings for carrying out transplanting is 15-20 days. Exceeding this age will cause high transpiration from seedlings and, consequently, adversely affect the yield. The best yield is obtained by transplanting the seedlings the same day they are removed from the nursery bed (Biswas, 1981). Thus, timeliness of transplanting is a very important factor that influences productivity of rice. The average yield of rice in Chhattisgarh State is very low (1.2 t/ha) as compared to other Indian states like Punjab, Tamilnadu and West Bengal where average yields of rice have reached up to 3.5-4.0 t/ha (**Fig. 1**). Frequent dry spells result in great instability in rice yield and land use intensity. Once the crop has failed, there is an acute shortage of employment for the rural people. Direct seeded and transplanting methods are the most commonly used practice of rice cultivation (Anonymous, 2005).

The direct seeding method is in use in both upland and low land. Due to uncertainty about the rainfall

and due to limited resources, farmers have always faced the problem of deciding which rice cultivation method to adopt. Some of the merits and demerits of prevailing rice cultivation's practices of Chhattisgarh are given in **Table 1**.

The un-sustainability and low rice yield under rainfed conditions are associated with many supportive constraints such as natural, biological, physical and socio economic.

**Natural Constraints**

**Rainfall Variability**

Analysis of rainfall data of the last 25 years indicate that about 50 % of rainfall occurred in a few storms that last for a total of 20-30 hours. This is hardly 1 % of the total number of hours in the rainy season when rice is grown. A large amount of water from these storms is lost by runoff, seepage and deep percolation. The remaining 99 % of the crop growing period must depend on the remaining 50 % of rainfall, which is not well distributed. Variability in rainfall and evaporation is shown in **Fig. 2**.

**Complex Performance of Soil in Different Moisture Regimes**

Rice is grown in loam, silty clay loam and clay soil. Due to the presence of clay and iron oxide in the

soil of Chhattisgarh, it becomes very sticky when moisture content is above 18 % and very hard when the moisture content is reduced to 7 % or less. Under this situation, working with animal power and traditional implements are difficult.

**Biological Constraints**

Low crop production is partially due to the use of the traditional variety and the High Yielding Variety (HYV) that are both suitable for irrigated, transplanted rice. However,

when these varieties are used in the rainfed area their yield is seriously reduced.

**Management Constraints**

During the peak season for transplanting, biasi and weeding, there is a shortage of labour, as these operations are performed by the human labour for all farmers. Transplanted and direct seeded rice is not sown in rows, so control of weeds is not possible with a mechanical weeder. Due to drudgery involved in agri-

**Table 1** Merit and demerits of existing rice cultivation practices in Chhattisgarh

Cultivation practices	Merits	Demerits
<b>Direct seeded</b> Broadcast Biasi	Less labour requirement	High weed infestation
	Yield is stable under uncertain rain	Low yield as compare to transplanted rice
Row seeding	Cost of cultivation is low	Wild rice infestation
	Drought risk avoided	High seed rate
	Rice yield is closed to transplanted rice	Needs well-prepared field.
<b>Transplanting</b>	Mechanical weed control	Needs efficient row seeding and weeding implement
	Drought risk avoided	
	High yield, less weed infestation control against wild rice	High energy and input cost Need water management Labour intensive job

**Fig. 1** Average yield of rice in major rice growing state of India

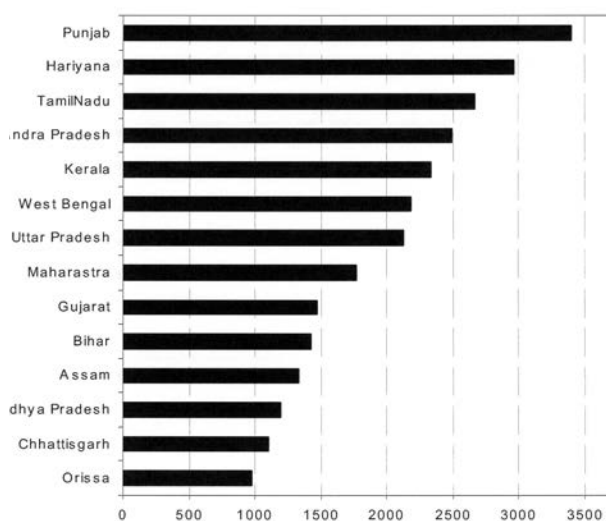

**Fig. 2** Weekly average rainfall and evaporation for chhattisgarh, India

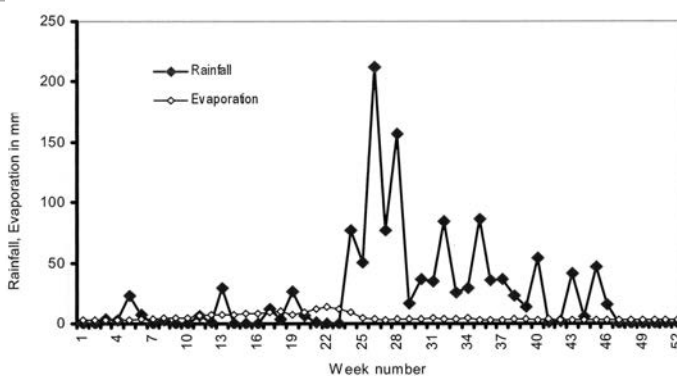

cultural operations, particularly in rice cultivation, and due to rapid industrialization in Chhattisgarh, the availability of agriculture labour is very limited.

## Materials and Methods

To achieve the objectives of the present study, a benchmark survey was conducted in selected villages of Chhattisgarh. The energy use patterns in direct seeded and transplanted rice cultivation were collected. Participatory Rural Appraisals (PRA) conducted in the Chhattisgarh plane, particularly in Durg, Rajanandgaon, Janjgir and Raipur Districts during 1995-97 were used as secondary data. On the basis of these surveys and PRA experiences, experiments were conducted in the experimental fields of the Faculty of Agricultural Engineering, Indira Gandhi Agricultural University, Raipur, Chhattisgarh, India during 1997-2001. These were used as primary data to determine the energy use in rice cultivation. The data generated through these experiments were used in decision modeling for mechanization strategies of rice cultivation in Chhattisgarh. Due to diversity in economical status of farmers, there was a broad difference amongst the farmer for adoption of technology. For resource rich farmers, almost all the agricultural operations were performed by the machine, Small and marginal farmers, depended upon animal power. To help understand the problem of the mechanization gap, the problem diagram is shown in Fig. 3.

### Decision Modeling in Rice Crop Establishment Technique for Sustainable Yield

Examination of the unsustainable rice production, as discussed above, along with the experimental results and energy survey report identify two areas of consideration for to overcoming the drought problems.

Fig. 3 Problem diagram for unsustainable rice production

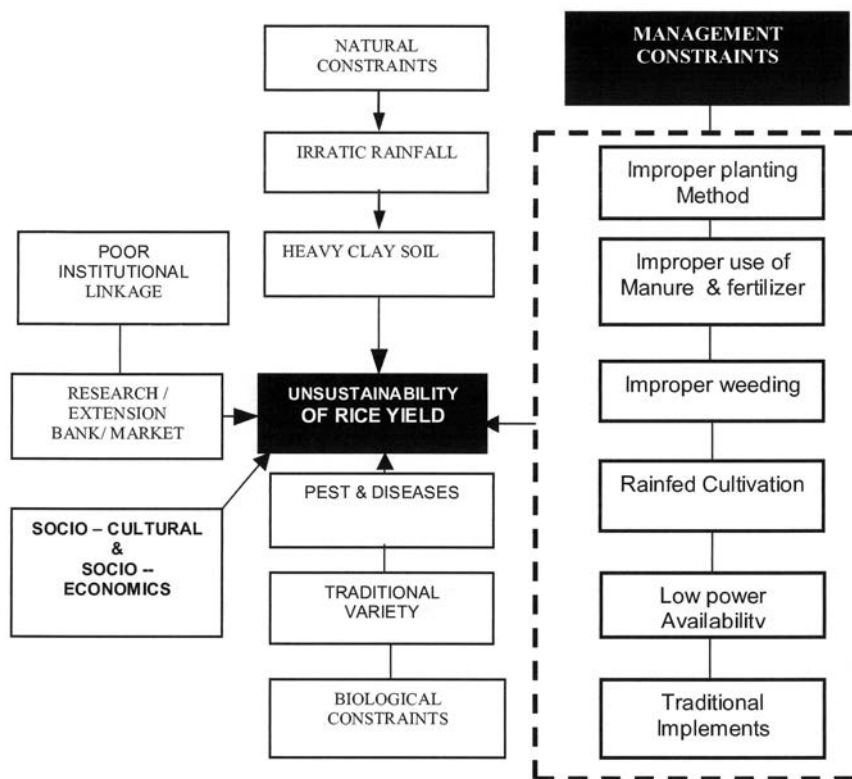

Fig. 4 Rice crop establishment decision model for dry seeding

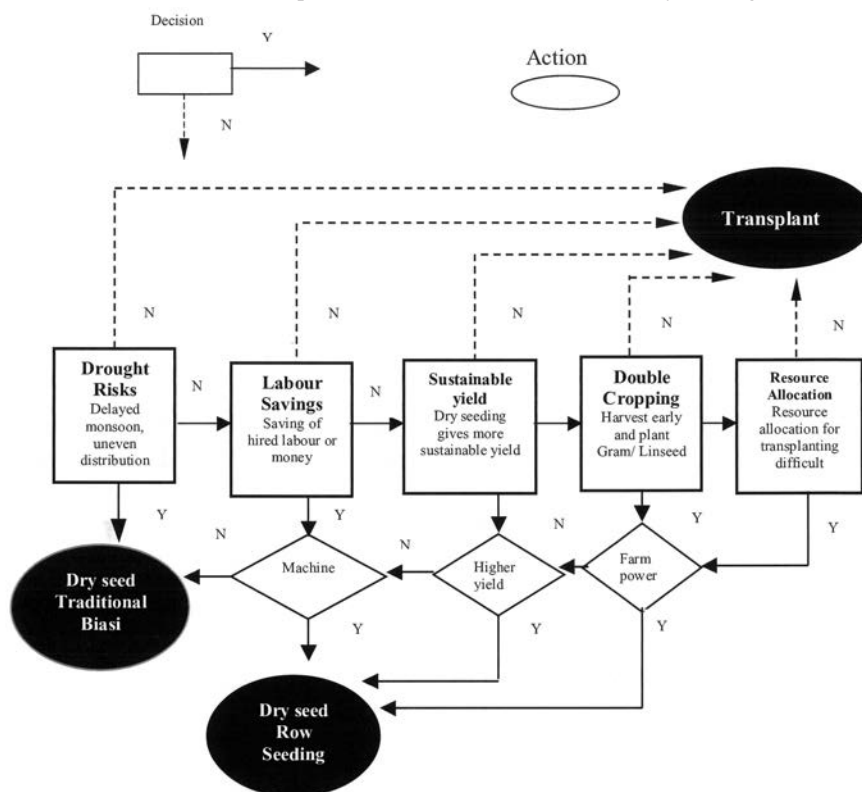
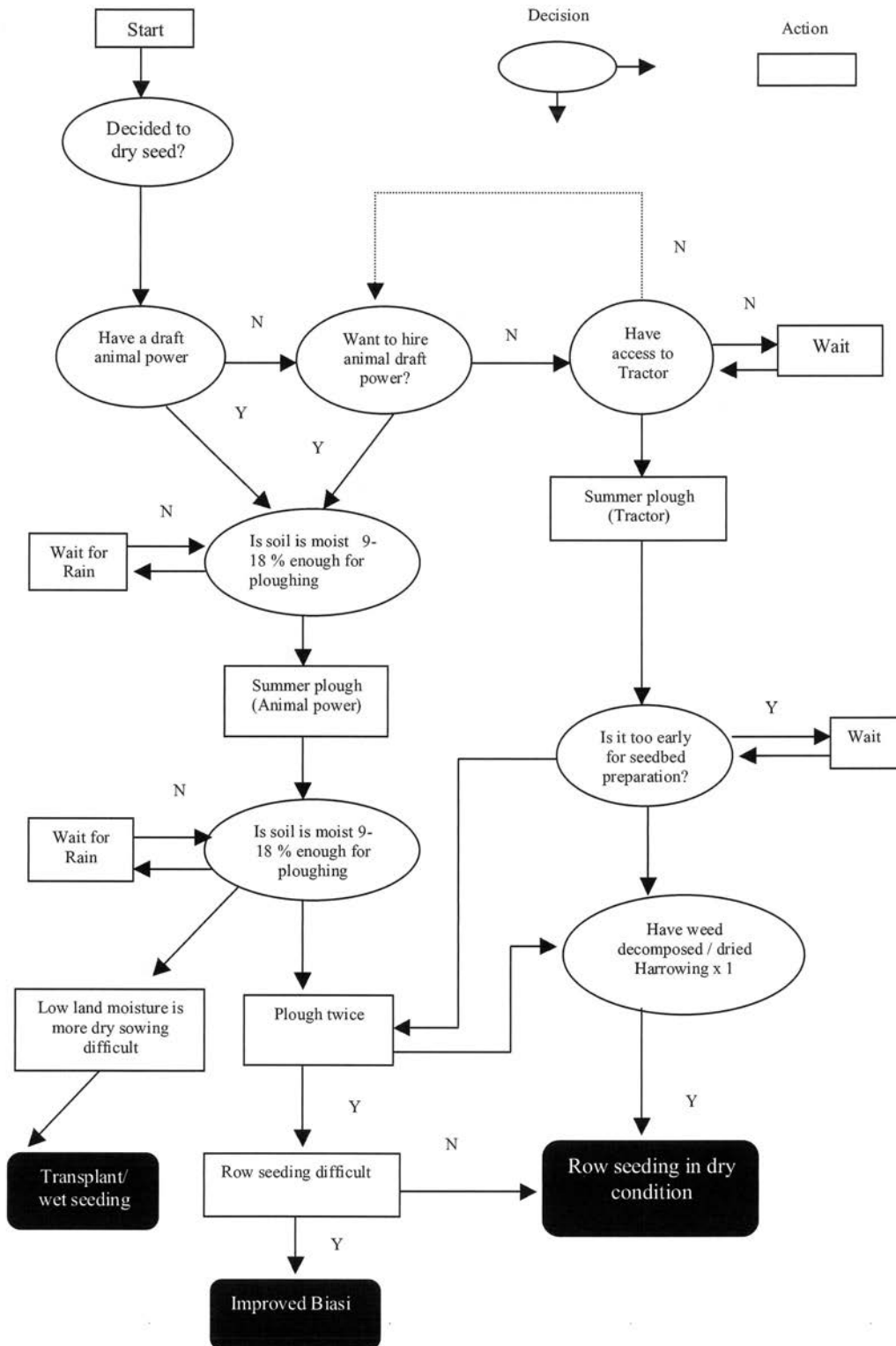

Fig. 5 Implementation of rice crop establishment technique



- a. To increase area under irrigation
- b. To advance the crop schedule by dry seeding of rice

With available information and analysis of these two possibilities, the first possibility seems to be difficult. The irrigation projects are expensive and have faced a lot of social and economical problems. Also the rate of increase in irrigated land per year since 1965-66 is only 0.44 % of the total cultivated land. The second possibility is more promising because of proper management of land, water and other available resources. The decision-making process and particular, the implementation of the decision to switch from traditional broadcast biasi and transplanting to dry seeding is rather complex. The idea of a three-stage model of rice crop establishment decisions is used for Chhattisgarh rainfed rice cultivation. The first stage of the model deals with the motivation and externalities involved in the decision-making process (Fig. 4). First priority has been given to the drought risk. Labour

saving, sustainable yield and double cropping depend on the machinery management and their availability. Energy efficient machinery and mechanical power availability are the major factors to decide between row seeding and direct broadcast seeding.

The dry seeding has been decided in stage I as discussed above and the model considers the subsequent steps, systematically, in a time sequence. The main problem farmer's face is how to prepare land before monsoon rains. It can be solved by the use of improved implements and mechanical power. At the same time seeds can be sown in rows with seed

drill. The depth of seeds must be 4-6 cm below the soil surface. Because of the seed depth, these seeds germinate when there is sufficient rainfall (up to 120-140 mm). In the traditional biasi system, 200-275 mm water are needed to germinate the crop. In direct row seeding there is no need of biasi operation. However, biasi is only possible when there is an accumulation of 5 to 10 cm water in the field. By the direct row sowing, germination of rice starts about 15 days in advance in comparison to the traditional system. Many researchers have found that the total water requirement for direct row seeded rice is 550-600

**Table 3** Average energy consumption in rice production in Chhattisgarh

Particulars	Direct Seeded		Transplanted	
	Broadcast Biasi	Row seeding	Random	Row
Total energy, MJ/ha	12,304.7	10,916.4	11,135.8	11,510.8
Yield, kg/ha	2,509	3,488	2,805	3,004
Specific Energy, MJ/kg	4.90	3.12	3.97	3.82
Energy productivity, kg/MJ	0.204	0.320	0.252	0.261
Labour Input man-days/ha	244.3	183.2	204.00	154.10
Labour productivity, kg/man.day	10.27	19.00	13.75	19.41

**Table 2** Total energy use and cost requirement for rice cultivation

Particular	Direct seeded				Transplanted			
	Broadcast Traditional (A)		Row Improved (B)		Random Traditional (C)		Row Improved (D)	
	Energy MJ/ha	Cost Rs/ha	Energy MJ/ha	Cost Rs/ha	Energy MJ/ha	Cost Rs/ha	Energy MJ/ha	Cost Rs/ha
<b>Farm operation (Direct energy)</b>								
Land preparation	1,600.6	2,674.0	1,417.6	2,365.0	1,924.9	3,093.0	2,485.3	2,774.0
Sowing / Nursery	471.2	806.0	180.3	303.0	-	312.0	-	296.0
Transplanting	-	-	-	-	838.9	1,695.0	945.7	1,890.0
Interculture	1,830.1	3,646.0	1,069.6	2,183.0	480.2	1,980.0	269.6	550.0
Plant protection	-	-	11.0	-	14.6	-	15.8	-
Fertilizer application	23.0	183.0	23.0	183.0	23.0	208.0	30.0	208.0
Water Management	49.0	-	49.0	-	58.8	-	58.8	-
Harvesting	432.3	1,103.0	487.9	1,245.0	405.8	1,035.0	414.3	1,057.0
Transportation	200.5	421.0	242.0	518.0	271.1	603.0	386.1	615.0
Threshing	565.2	1,072.0	508.4	900.0	646.3	1210.0	432.2	900.0
Sub Total (I)	5,171.9	9,905.0	3,988.8	7,697.0	4,663.6	9,136.0	5,037.8	8,290.0
<b>(Direct energy)</b>								
Seeds	1,528.8	660.0	1,293.6	440.0	808.5	275.0	808.5	275.0
Fertilizer	5,604.0	-	5,604.0	1,597.0	5,604.0	1,597.0	5,604.0	1,597.0
Superior chemicals	-	1,597.0	30.0	100.0	59.7	200.0	60.5	200.0
Sub Total (II)	7,132.8	2,257.0	6,927.6	2,137.0	6,472.2	2,072.0	6,473.0	2,072.0
Total (I) + (II)	12,304.7	12,162.0	10,916.4	9,734.0	11,135.8	11,008.0	11,510.8	10,362.0

mm of water, where as, in the traditional method 700-800 mm of water is required. So, by the advance in cropping schedule, direct row seeded rice gives more sustainable yield (Fig. 5).

### Energy Studies in Experimental Field

The soil of the experimental field was silty clay loam with 21.4 % sand, 40.3 % silt and 38.3 % clay. On an average, the initial bulk density and cone index for a depth of 0-150 mm was 1.60 g/cc and 8.87 kgf/cm<sup>2</sup>, respectively, at an average moisture content of 16.7%. The experiments included animal drawn and tractor drawn farming with both the traditional method (by using traditional implement) and improved method. The area of each plot was 20 × 40 m<sup>2</sup>. The measurement of draft, speed and operational time for each operation were done individually. The recommended doses of fertilizers were applied on the basis of the soil fertility for each experimental plot. The crops were grown under rainfed condition. Ob-

servations on germination, tillering and yield were recorded. The energy equivalence for direct and indirect sources suggested by Binning *et al.* (1984) was used.

### Results and Discussion

#### Energy use and Cost of Production in Rice Cultivation Practices

Energy and cost of production for cultivation of rice in direct seeded (broadcast biasi and row seeding) and transplanting method are given in Table 2.

Cost of cultivation was higher for transplanted rice. With respect to the establishment method, the direct seeded had lower energy consumption (1,597 MJ/ha) and lower cost of operation (Rs.2,668/ha). In Chhattisgarh, the direct seeded crop establishment method is used by the majority of farmers because of lower cost and less risk from drought. The cost of production for the transplanted method was 1.5 to 2 times higher than the direct seeded method. In both sys-

tems of cultivation (by row seeding and transplanting), energy and cost requirement for weeding were 40 % less than broadcast seeded and random transplanting. The reason for this was due to use of the mechanical weeder between rows. The energy requirement for harvesting, threshing and transportation mainly depended upon the performance of the crop. However, the total direct energy and cost of cultivation in row seeded, direct sown rice by the use of improved implements were 3,988 MJ/ha and Rs.7,158/ha, which were about 33 % and 21 %, respectively, less than the traditional method. It is interesting to note here, particularly in tillage operations with a tractor, time of operation and cost of cultivation could be reduced about 90 % and 42 %, respectively, in comparison to animal farming. Similar results were also observed for threshing operations with an electric powered thresher over threshing by animal treading. The cost of threshing for animal treading and electric powered thresher were Rs.450/t and Rs.265/t, respectively.

**Table 4** Effect of system of cultivation on crop parameters

Cultivation System	Germination, Plant/m <sup>2</sup>	Tillering, Tillers/m <sup>2</sup>	Average height of plants, cm	Average height of panicle, cm	Grain yield, kg/ha	Straw, kg/ha
<b>Direct sown</b>						
Traditional (Broadcast)	57	181	67.0	18.3	2,509	3,051
Improved (Row seeded)	85	236	75.8	22.8	3,488	4,176
<b>Transplanted</b>						
Traditional (Random)	41	258	70.2	19.3	2,805	3,318
Improved (Row)	46	270	71.8	20.7	3,004	3,581

**Table 5** Output- input ratio for traditional and improved methods for rice cultivation

Cultivation system	Energy out put MJ/ha × 10 <sup>3</sup>			Energy input MJ/ha × 10 <sup>3</sup>		Energy out put - input ratio	
	Grain	Straw	Total	Direct + energy input tillage to threshing	Direct + indirect energy from tillage to threshing	Tillage to threshing	Total (direct + indirect)
<b>Direct seeded rice</b>							
Traditional	36.9	38.1	75.0	5.17	12.30	14.26	5.99
Improved	50.3	52.2	102.5	3.98	10.91	25.76	9.39
<b>Transplanted</b>							
Traditional	41.2	41.5	82.7	4.66	11.35	17.74	7.28
Improved	44.1	44.8	88.9	5.07	11.51	17.53	7.72

### Average Energy Consumption in Rice Production in Chhattisgarh

Energy use and production cost in various rice cultivation practices in Chhattisgarh were compared on the basis of specific energy, energy productivity and labour productivity (Table 3).

The production of 1 kg of rice by the traditional broadcast method required the highest energy (4.9 MJ/kg). In comparison to the traditional broadcast method, direct row seeded rice required 36 % less energy. One MJ of energy for row seeded rice had the highest yield as compared to the other method.

### Comparison of Yield and Agronomic Parameter

The same variety of rice MW-10 (short duration 100-110 days) was sown in all the experimental fields during the year 1997 to 2001. The effect of various treatments on average germination, tillering and yield is given away in Table 4. Germination rate, tillering and yield were maximum for the improved method. The direct row seeded method gave the highest yield (3,488 kg/ha) followed by row-transplanting (3,004 kg/ha), traditional, random transplanting (2,805 kg/ha) and the traditional broadcasted biasi method (2,509 kg/ha). The average yield for the improved method was 28 % more than the traditional direct sown broadcast method. More yield under improved conditions was due to better tilth, better germination rate, more tillers per unit area, and healthy plants because of proper utilization of fertilizer. Also, row to row seeding promoted better sunlight penetration.

### Energy Out put- Input ratio

The energy available from grain and straw represent the energy output where as energy consumed

in various operations represents energy input. (Gupta *et al.*, 1994). The total direct and indirect energy including seed, fertilizer and chemical energy and energy out put input ratio are given in Table 5.

Total energy use in direct sown rice was in the range of 10000 MJ/ha to 12,000 MJ/ha with output energy of 73760 MJ/ha to 102,540 MJ/ha. Energy output-input ratio varied from 5.99 to 9.39 and 7.28 to 7.72 for direct sown and transplanted rice.

### Conclusions

Direct row seeded rice crop establishment technique was as suitable for drought risk and had more sustainable yield as compared to the other rice cultivation practices used in Chhattisgarh. The row seeding method of rice cultivation was most effective for energy saving and better yield as compared to traditional broadcast biasi system of cultivation of rice. Row seeding by seed drill saved about 40 to 45 % of energy for the weeding operation as compared to traditional broadcasting system.

In transplanted rice, puddled seedbed preparation and transplanting of rice seedlings was the most energy-intensive operation and consumed 42 to 48 % and 15 to 18 % of the total energy in the field operation. Initial energy input and cost input of the transplanted method was higher than the direct seeded. Transplanted rice was more susceptible to drought and more dependent on availability of water. Frequent dry spells, monsoon breaks and uneven distribution of rainfall were a common feature of rice cultivation in Chhattisgarh. Under these circumstances direct seeded rice cultivation practice was identified as an alternative to broadcast biasi system.

### REFERENCES

- Anonymous. 2004. Agricultural Statistics at a Glance- Directorate of Economics and Statistics, Department of Agriculture and Cooperation, Ministry of Agriculture, Govt. of India, New Delhi. India.
- Anonymous. 2005. Directorate of Economics and Statistics, 2005-06. Directorate of Economics and Statistics, Department of Agriculture and Cooperation, Ministry of Agriculture, Govt. of India, New Delhi. India.
- Binning, A.S., B. S. Pathak, and B. S. Panesar. 1984. Energy audit of crop production system. Research Bulletin. School of Energy Studies for Agriculture, P.A.U, Ludhiana.
- Biswas, H. S. 1981. A Review on Rice Transplanters and Paddy Seeders. Central Institute of Agricultural Engineering, Bhopal, India.
- Fujisaka, K., T. Ingram, and K. Moody. 1991. Crop Establishment (Beusani) in Cuttak District, India, IRRI, Research paper series Number 148 page 2-7.
- Gupta, C. P., T. Herwanto. 1992. Design and Development of a Direct Paddy Seeder. AMA Vol. 23 page 23-27.
- Jacobi, B. 1974. Some aspects of soil tillage for low land rice in Orissa, Report on expert Consultation Meeting on the Mechanization of rice production. IITA, Ibadan, Nigeria page 89-91.
- Verma, A. K. 2002. Audit of Energy requirement on cultivation of rice for small farming condition. AMA Vol. 33. page 45-49.

■ ■



# Argan Nut Cracker for Southwestern Moroccan Women

by  
William S. Kisaalita  
Professor and Graduate Coordinator  
Biological and Agricultural Engineering  
College of Agricultural and Environmental Sciences  
and Faculty of Engineering  
Driftmier Engineering Center  
Athens, GA 30602, GREECE  
williamk@enr.uga.edu

Meghan Shealy

Max J. Neu

Philip Jones

Jonathan Dunn

Undergraduate Student  
Biological and Agricultural Engineering  
College of Agricultural and Environmental Sciences

## Abstract

Southwestern Moroccan women crack the hardest nuts (Argan) in the world between two stones by hand for nine hours a day, six days a week. Most women complain of pain in the fingers due to the repetitive nature of the cracking activity and some suffer from broken fingers. They receive little compensation for this hard work and, as a result, have formed cooperatives for both companionship and improvement in productivity. Nut cracking is the bottleneck in the overall process of oil production from the nut kernel. In an effort to strengthen the women's cooperatives, a simple device was designed, fabricated and tested with the goal of increasing productivity while alleviating the dangers of hand cracking. Testing of 30 Argan nuts from the Touradant region of Southwestern Morocco was performed on a material testing machine to establish the force to crack the shell in relation to nut orientation. The results revealed no significant relationship between dimensional properties of the Argan

nut and the cracking force. This information was used in the development of a hand operated nut cracking device. The device included a lever arm, an autoloader (rotator hexagonal wheel) and the associated harmonizing mechanism, a nut feed hopper, a cracking ram and plate, and a wooden housing that held all the elements together. The cost was estimated to be below US\$100.00, essentially a fifth of what the women currently earn in a year. The device

performed satisfactorily with respect to yielding intact kernels. However, further modifications were needed before realizing the target increase in cracking speed. Funding is being sought to fabricate and test the second generation device in the hands of the Moroccan women.

## Introduction

The Argan tree (*Argania spinosa*),

---

## Acknowledgements

Travel support from the University of Georgia Office of the Vice President for Public Service and Outreach (OVPSO) and the University of Georgia College of Agricultural and Environmental Sciences (CAES) Global Programs Office are acknowledged. The support from CAES enabled travel to Morocco in June 2005 by WSK with the purpose of establishing collaboration and gaining first hand knowledge of the Argan oil production process and its relationship to the overall effort to improve the tree potential. The

support from OVPOS enabled WSK and four undergraduate students to travel to Morocco in March 2006 to present a range of possible solution concepts and to extensively consult the women and other stakeholders to arrive at the most desirable solution concept to pursue. We also acknowledge technical assistance from Drs. Tim Foutz (University of Georgia, Athens, USA), Fouad Rachidi and Ali Lansari (National School of Agriculture, Meknés, Morocco), and Lahcen Kenny (Institut Agronomique and Veterinaire Hassan II, Agadir, Morocco).

also commonly known as ironwood, is endemic to Southwestern Morocco and is prized for its edible oil, dense wood, valuable forage, and potential for reforestation in efforts to slow desertification in the Sahel (Morton *et al.*, 1987; Prendergast and Walker, 1992; Nerd *et al.*, 1994; Charrouf and Guillaume, 1998). Unfortunately, in less than a decade, more than a third of the Argan forest has disappeared, and its average density has declined from 100 to 30 trees per hectare (Rachidi, 2005). Of all the products from the Argan tree, the oil extracted from the seed or nut kernel is the most important to the local economy. Production of Argan oil is traditionally a female activity with labor and time intensive methods. It involves semi-wet fruit collection from the forest, drying and outer skin removal by hand. The resultant nut or

seed is cracked manually between two stones (**Fig. 1**). Argan nuts have extremely hard shells. In some instances it takes three stone strikes to retrieve the kernel. The kernels are separated from the broken shell pieces and are pressed to yield the oil. The kernel may be roasted first depending on the intended end use of the oil. High quality Argan oil is valuable for culinary, cosmetic and medicinal purposes; it is rich in vitamin E and is claimed to be unique and optimal for human health. It is high in antioxidant activity and has organoleptic qualities, containing 80 % unsaturated fatty acids (Khalilouki *et al.*, 2005).

Moroccan women crack Argan nuts by hand for nine hours a day, six days a week. Receiving little compensation for this work and with the prospects of broken fingers, these women have formed coopera-

tives that produce small quantities of high quality oil from Argan tree nuts that is sold both locally and in European markets. A few of these cooperatives specifically provide employment and emotional support to battered, divorced, or unwed mothers.

Although high speed high tech mechanization of the cracking process would relieve the women, they are opposed to the idea due to well founded job loss fears. Increasing the profitability of the process by eliminating the slow cracking bottleneck would render the industry attractive for men and/or high end investors. The objective of the project was to find a culturally sensitive solution that would strengthen the cooperatives while preserving the social-economic role the nut-cracking activity provides for the women and their families.

**Fig. 1a** Map of southwestern Morocco showing the current distribution of Argan forests



**Fig. 1b** Argan fruit



**Fig. 1c** Argan tree with foraging goats



**Fig. 1d** Moroccan women from Doutamma Cooperative, Tezerini, Agadir, cracking Argan nuts - one at a time - with a stone. The left hand holds the nut and the right hand strikes one to three times. Most women reported pain in the two fingers of the left hand that holds the nut. Some women sustain injuries due to direct hit with the cracking stone



### Argan Nut Force-Deformation Studies

Before considering any solution concepts, it was necessary to establish the force required to crack the nuts and how the force is related to nut sizes. This information was considered important in guiding the thought process to determine viable approaches to Argan nut cracking.

### Materials and Methods

Testing was performed on Argan nuts that were harvested during May of 2005 and March of 2006 from the region of Touradant in Southwestern Morocco. The size distribution statistics of 100 randomly selected nuts are presented in **Table 1**. Through visual inspection, all nuts with either damaged shells or were tri-planar (contained three kernels) were left out of the study. Only nuts with one complete cleavage plane or suture (**Fig. 2**) were included in the compression study.

Before each nut was loaded, its weight, length and both major and

minor diameters were recorded. The major diameter of the nut was the distance from the cleavage line (suture) on one side of the nut to the other. All compression loading was performed on a material testing machine manufactured by Instron Corporation, Norwood, MA (Model 1120, recently discontinued and replaced by Model 3340). The maximum force applied to the nuts was restricted to 1,100 lbf based on the capacity of the load cell available on Model 1120. The nuts were placed between two parallel plates and their orientation was restricted to axis 3 (Fig. 2). This axis was determined to be the weakest axis of the nut through preliminary testing. The force was applied so that it ran approximately perpendicular to the cleavage plane. Compression perpendicular to axis 2 revealed this to be hardest approach to cracking the nuts. In preliminary testing, routine machine shut-off was observed due to forces exceeding the load cell capacity. However, the forces required were reduced when shells were weakened by puncturing with sharp objects. The nuts were compression loaded until shell rupture was initiated. Force versus deformation curves were captured by a chart

recorder, which ran at 20 times the speed of the loader. The nuts were compressed at a constant rate of 0.3 inches per minute. Once the initial shell rupture was reached the force was removed from the nut, resulting in the typical force-deformation curve as shown in Fig. 3.

## Results, Discussion and Concluding Remarks

The mechanical response of the Argan nuts was expressed in terms of force required for maximum strength of the shell to be achieved, energy required to deform the nut shell to the initial rupture and nut specific deformation. The values of the force and deformation for the initial rupture of the nut shell were obtained for each compression curve. Table 2 presents the results of the 30 tested nuts and summarizes the averages, standard deviations, maximum and minimum values for the peak rupture force required to crack the nuts, the specific deformation and the energy required to crack the nuts. Correlations between the rupture force and the major diameter ( $r = 0.608$ ), minor diameter ( $r = 0.572$ ), length of the nuts ( $r =$

0.284) and shell thickness ( $r = 0.553$ ) were considered weak. The suture lining seemed to be the weakest part of the nut since the nuts predominantly cracked along this line. By slightly orienting the nuts a few degrees so the compression forces exerted a shearing action along the suture, lower forces were required and the cracking was cleanly along the suture providing intact kernels.

The average force of 354.2 lbf was considered high, suggesting that Argan is probably one of the hardest nuts to crack. The forces required exceeded forces required for Macadamia (Braga *et al.*, 1999) that is considered to be a very hard nut to crack. At this level of hardness, commonly used high speed impact machines are not applicable

Fig. 2 Representation of three possible directions for the Argan nut compression

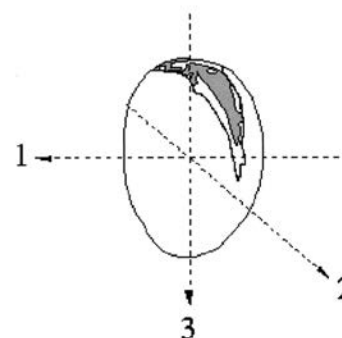

Fig. 3 Typical force-deformation curve for compressed Argan nuts.

The smallest vertical unit represents one lbf while the smallest horizontal unit represents a compression of 0.0094 %

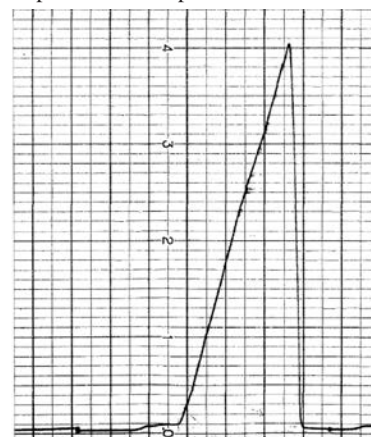

Table 1 Physical properties of tested nuts

	Length, inches	Major Diameter, inches	Minor Diameter, inches	Mass, grams	Shell Thickness, inches
Average	0.863	0.549	0.510	2.212	0.095
Standard Deviation	0.1020	0.0458	0.0430	0.5510	0.0215
Maximum Value	1.139	0.692	0.646	4.340	0.143
Minimum Value	0.655	0.481	0.445	1.400	0.058

Table 2 Mechanical properties of tested nuts

	Rupture Force, lbf	Specific Deformation, %	Energy, lbf-inch
Average	354.2	9.18	8.965
Standard Deviation	109.5	1.95	3.348
Maximum Value	711.7	13.75	16.277
Minimum Value	183.4	6.15	3.389

since the impact to crack the nuts also destroy the kernel. To be able to use simple compression approaches calls for a means of introducing weaknesses in the shell with sharp objects. Further testing of nuts from all regions of southwestern Morocco may be useful in determining if there are regional variabilities that may influence the nutcracker design.

## Solution Concept

The women as well as other stakeholders were adamant that they did not want technology that would replace them. Currently, an experienced woman may produce 0.5 to 1.0 kg of kernels per day. The target productivity that was determined through extensive consultations with the women was approximately 2-3 kg per day. Adapting technology for high speed and high volume that would replace the women would have adverse consequences in several ways. First, the women would lose the income; they are paid per kg of kernel produced. Second, the role the cooperatives that serve in the communities as a place for women - the young and the old - to gather, would be disrupted. For example, the young gain indigenous knowledge from the old and all receive services such as adult education (*e.g.*, learning to read and write). This role is very important in a Muslim society like Morocco, where community and family gender roles are distinct and are strictly observed (Mernissi, 1995). Some centers such as the Taitmatine Co-operative in Tiout only caters to unwed or divorced mothers or those having marital problems who would have nowhere to turn for financial and emotional support if they were no longer needed at the cooperatives.

Based on the above productivity requirements, a solution involving a simple hand-operated mechani-

cal device was considered to be the most ideal. The potential success of such a device was evaluated by stakeholders based upon attributes shown in **Table 3**. The design constraints imposed after lengthy consultations with the women workers are presented in **Table 4**. In addition to these constraints, it was highly desirable that the device be operated by one person, load the nuts, crack their shells while preserving the kernel and discharge both the kernel and shells. From benchmarking and preliminary force testing analysis as presented above, it was concluded that all commercially available one-nut-at-a time crackers (*e.g.*, one made by Kenkel, Inc., the Walnut Cracker, etc) could not

adequately meet the productivity requirements. One-nut-at-a-time crackers sold in the west are designed for commercial or domestic kitchen use where productivity was not an issue. Also, as stated above, commercial high speed impact type crackers were not suitable, because accelerating the nuts to speeds high enough to crack the shells destroyed the kernel. The approach adopted was to extend the one-nut-at-a-time designs by providing the possibility to crack more than one nut at a time in one forward stroke in addition to "automatic" loading of nut while discharging the kernel and shell all in one back stroke.

**Table 3** Design attributes in order of decreasing importance

Attribute	%	Comment
Safe	11	Minimal moving parts
Efficient	9	High kernel yield
Accurate	9	Low uncracked nuts
Woman friendly	8	Appealing to women
Ergonomic	8	Comfortable to operate
Sanitary	8	Ensure safe and clean kernel
Fabricated from local materials	8	Promote local industry
Automatic feed/disposal	7	Probably most effective way to achieve the desired productivity
Manual power	6	To keep it simple and cost-effective
Easy to operate	6	Keep the forces low to minimize fatigue
Durable	5	Maximize internal rate of return
Inexpensive	5	Maximize internal rate of return
Easy to repair	4	Maximize adoption rate
Lightweight	2	Portable
Mobile	2	Portable
Weather resistant	1	Withstand high temperatures and dust
Small size	1	Appealing to women
Quiet	0	Carry on a conversation in a room with several devices in operation
TOTAL	100	

**Table 4** Engineering constraints

Constraint	Value	Constraint	Value
Cost	< US\$ 250.00	Input force	5-10 lbf
Weight	< 50 Lbs	Feed speed	> 36 nuts/min
Life span	> 5 years	Safely	< 1 scrape/month
Steps to assemble or disassemble	< 75-80 dba	Size - foot print	2 ft by 2 ft
Noise	< 55 dB (A)	Education level for use or repair	Elementary

## Design Details, Fabrication, Operation and Cost Estimates

**Figs. 4 and 5** show details of the first prototype designed to meet the needs of the women; it is composed of six main components; a lever arm (1) that both operates the cracking ram (2) and the hexagonal rotator wheel with plate spokes (3) that feeds the nuts from an inclined hopper (4), and a wooden housing (5) that holds all the components together. Not shown in **Fig. 4** is a novel internal mechanism (6) that harmonizes the movements of the ram and the wheel. The basic operation of the device is as follows: 1) begin with a lever arm in a vertical position, 2) push the level arm forward to drive the horizontal ram which cracks the nuts confined by the ram head, the crack plate, and the rotator wheel plate spokes, 3) pull the lever backwards causing the wheel to rotate, discarding the cracked nut (kernel and shell) while loading new nut in position for the next cracking cycles. Current two-stone cracking rates can be tripled if not quadrupled by rocking the lever forward and back with one hand while the second hand is free to facilitate nut flow from the hopper and into the cracking area,. More detailed design considerations are

provided for each component in the following subsections.

**Lever arm:** A one inch hollow milled steel square tube was chosen based on cost and local availability. Although women between the ages 18 and 50 years can exert an average force of 50 lbf (Kroemer *et al.*, 1997) with one hand, the rod was made long enough (39 inches) for input forces to be less than 10 lbf that can easily be applied without fatigue for long working hours.

**Cracking ram and plate:** Ridges were introduced at the tip of the cracking ram and plate. The ridges concentrate the pressure on the shell resulting in cracking forces much lower than the 360 lbf force determined in the first part of the study. The ridges were incorporated on the ram and plate by welding ridged plates.

**Rotator hexagonal wheel and harmonizing mechanism:** This is the “heart” of the device. The harmonizing mechanism is composed of four main subcomponents (6a, 6b, 6c, and 6d in **Fig. 5**, top). The hexagon wheel (3) is rigidly fixed on part 2 (6b). Parts 1 (6a) and part 3 (6c) are rigidly joined and constrained to the linear motion. Part 2 (6b) is constrained to rotational motion. Upon movement of the lever (left of the

paper), part 1 moves away from part 1. The pin (6d) encounters the teeth of part 2 causing a small incremental rotation of part 2 and the wheel. Simultaneously, the ram is moving towards the back cracking plate and is cracking the loaded nuts. When the operator hears the sound the cracked nuts make, she reverses the lever movement to the right, which moved part 1 forward towards part 2. As shown in the detailed drawing of parts 1 and part 2 (**Fig. 5** bottom), full engagement of these parts causes a 60 degree rotation of part 2 and the attached wheel. Simultaneously, the ram is withdrawn from the cracking area allowing the unloading of the shell and free kernel and loading of an intact nut for the next cycle. The exactness of the part dimensions is important to achieving the harmony between cracking, discharge of kernel and shells, and loading of nut for the next cycle. Due to potential for wear, these parts were made of hardened carbon steal.

**Feed hopper angle of inclination:** The objective was to allow a few nuts at a time to roll into the cracking space. Theoretical calculation of the angle of inclination that would allow rolling of the nuts without sliding (Mohsenin, 1970) was

**Fig. 4** Schematic of hand-operated argan nut cracker

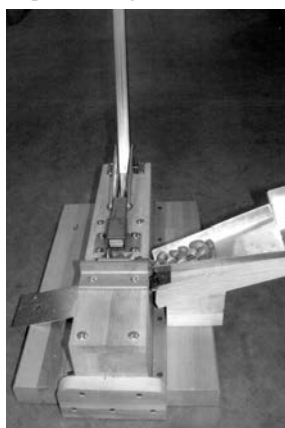

**Fig. 5** Left: Harmonizing mechanism for wheel rotation and nut cracking ram 1. lever arm, 2. cracking ram, 3. hexagonal rotating wheel, 4. hopper - not shown in the drawing, 5. wooden housing, 6. harmonizing mechanism composed of four subparts, and 7. cracking plate. Right: Detailed drawing showing the engagement mechanism that converts the horizontal motion (6a) into the rotational motion (6b)

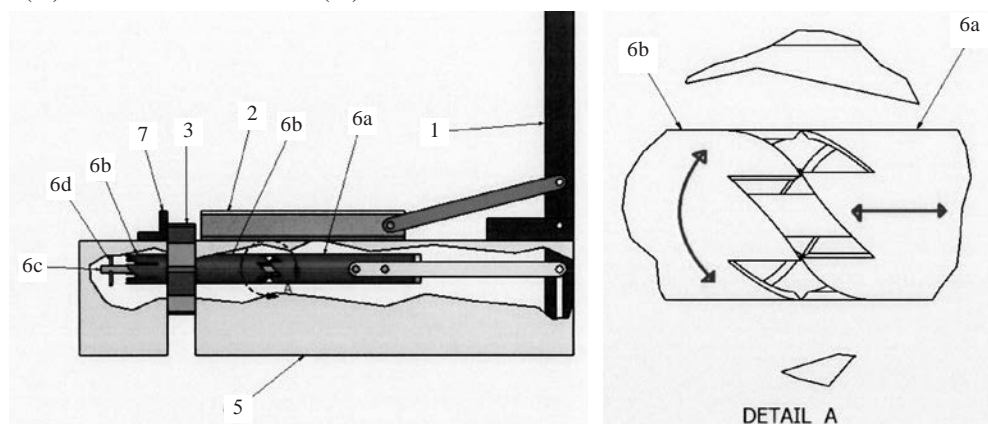

found to be 30 degrees. But by trial and error, the best angle of inclination of the aluminum hopper that yielded smooth movement of the nuts towards the rotator wheel was found to be 20 degrees. The open hopper design was preferred to the closed type to allow the operator to use her free hand to guide or load nuts into the hopper without stopping the lever arm movements.

**Housing and other components:**

Hard wood was used for housing the nut cracking components as shown in Fig. 4. Wood was preferred due to local availability and ease with which it could be machined to accommodate the structure. Standard calculations were used to ensure that other components used like pins and screws would not fail under the anticipated maximum loads (Faires, 1962). As is usually the case, it was difficult to predict the overall life of the device based on cyclic loading. This consideration was left to be addressed later after a satisfactory functional prototype has been established. For all parts in contact with the kernel (rotator wheel and the discharge plate), food grade stainless steel was used.

**Changes incorporated during fabrication and cost estimate:**

Changes incorporated during fabrication included making the housing in one piece and providing means by which regular cleaning and lubrication of the harmonizing mechanism can be conducted. Also, a screw to provide adjustment in the position of the pin was incorporated to be able

to adjust the harmonization between wheel rotation and ram linear movement, if off. Extra holes on the rod were provided to adjust the hinge of the ram to vary the extent of the ram liner motion. The material cost was estimated at approximately US\$ 65, but the overall cost including labor was expected to depend on number of parts made in a single batch and where they were made. However, it is reasonable to assume that the sale price would likely to be below US\$ 100.00. The pay back period should be less than a month since that the device should double or triple productivity.

**Test Results of the First Prototype and Concluding Remarks**

The device successfully cracked Argan nuts with respect to yielding intact kernels as shown in Fig. 6. The success was dependent on the sound the nuts made when they crack open. This signaled to the operator to reverse the forward movement of the cracking rod. The proper operation was quickly learned. The dimensions of the rotator wheel cracking space created between two plates at 60 degrees was too large and many nuts ended up in the space. As shown in Fig. 6, and it was not possible for the ram to crack all the nuts. A possible solution was to employ different sized wheels for nuts that are separated on the basis of size. It was not possible to test speed of cracking because the device could not be operated for a long enough periods before ceas-

ing. The rotational movement of the lever was intended to cause a linear motion of part 1 (Fig. 6). To achieve this, a long slot was milled in the lower end of the lever to relieve the tendency to “pry” part 1 upwards and the lever rotated about the main axis above the slot. The slot was not effective and the problem was solved by using a linkage between part 1 and the bottom of the level. However, use of the linkage would necessitate introducing a guide to prevent any rotational movement in part 1. Due to the “prying” tendency of part 1 by the lever in the current design, wooden chips from the housing were generated due to friction between part 1 and the housing. This contributed to jamming the harmonizing mechanism. It was proposed to use a plastic sleeve to house the harmonizing mechanism to both eliminate the jamming by wood chips and to provide a guide that would prevent any rotational movement of part 1. In conclusion, the preliminary experience with the first prototype suggested that high cracking rates might be achieved especially as operators get used to the device. Funding was being sought to fabricate a second generation device with the above modifications.

With the success of this device, anticipated short and long term impacts include: 1) adoption and widespread use of the device in Morocco, 2) increased Argan oil production from the cooperatives as well as improvements in the social-economic situation of Moroccan women through jobs and income, 3) reforestation with Argan trees and promotion of regional eco-tourism, and 4) local fabrication assembly and distribution to boost the metal fabrication enterprises in the region.

Fig. 6 Pictures of kernels (left) and nuts in the cracking space (right)

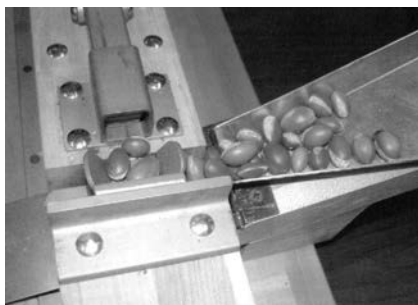

REFERENCES

Braga, G. C., S. M. Couto, T. Hara, and J. T. P. A. Neto. 1999. Mechanical behavior of Macadamia

- nut under compression loading. *Journal of Agricultural Engineering Research* 72: 239-245.
- Charrouf, Z. and D. Guillaume. 1998. Ethnoeconomical, ethnomedical, and phytochemical study of *Argania spinosa* (L.) skeys: A review. *Journal of Ethnopharmacology*, November.
- Faires, V. M. 1965. *Design of Machine Elements*. New York; Macmillan.
- Khallouki, F. B. Spiegelhalter, H. Bartsch, and R. W. Owen 2005. Secondary metabolites of the Argan tree (Morocco) may have disease prevention properties. *African Journal of Biotechnology*, 4(5): 381-388.
- Kroemer, K. H. E., H. J. Kroemer, and K. E. Kroemer-Elbert. 1997. *Engineering Physiology: Bases of Human Factors/Ergonomics*. New York: Van Nostrand Reinhold.
- Mernissi, F. 1985. *Beyond the Veil: Male-Female Dynamics in Modern Muslim Society*. Indianapolis: Indiana University Press.
- Mohsenin, N. N. 1970. *Physical Properties of Plant and Animal Materials*. New York: Gordon and Beach Science Publishers.
- Morton, J. F. and L. V. Gilbert. 1986. The Argan tree (*Argania sideroxyton*, Sapotacean), a desert source of edible oil. *Economic Botany* 41(2): 221-233.
- Nerd, A., E. Eteshola, N. Borowy, and Y. Mizrahi. 1994. Growth and oil production of Argan in the Negev desert of Israel. *Industrial Crops and Products* 2: 89-95.
- Prendergast, H. D. V. and C. C. Walker. 1992. The Argan multi-purpose tree of Morocco. *The Kew Magazine* 9: 76-85.
- Rachidi, F. 2005. Personal Communication. ■■

---

## NEWS

---

### ASABE 2010 Meeting and Conferences

- |                    |                                                                                                            |
|--------------------|------------------------------------------------------------------------------------------------------------|
| <b>June 13-16</b>  | 9th International Drainage Symposium<br>Quebec City, Canada                                                |
| <b>June 13-17</b>  | 17th World Congress Intl Commission of<br>Agr Engineering Quebec City, Canada, and<br>CSBE/ SOGAB 2010 AGM |
| <b>June 20-23</b>  | ASABE Annual International Meeting Pittsburgh,<br>Pennsylvania                                             |
| <b>Sept. 12-15</b> | Intl Symp, on Air Quality & Manure Mgmt<br>for Agriculture, Dallas, Texas                                  |
| <b>Nov. 14-17</b>  | TMDL 2010: Watershed Management to<br>Improve Water Quality, Baltimore, Maryland                           |
| <b>Dec. 5-8</b>    | 5th National Decennial Irrigation Conference,<br>Phoenix, Arizona                                          |

# Vibration Characteristics of Self Propelled Power Weeders

by  
K. Kathirvel  
Professor  
Department of Farm Machinery,  
Agricultural Engineering College  
& Research Institute,  
Tamil Nadu Agricultural University,  
Coimbatore- 641 003  
INDIA

S. Thambidurai  
Ph. D scholar  
Department of Farm Machinery,  
Agricultural Engineering College  
& Research Institute,  
Tamil Nadu Agricultural University,  
Coimbatore- 641 003  
INDIA

D. Ramesh  
Assistant Professor  
Department of Farm Machinery,  
Agricultural Engineering College  
& Research Institute,  
Tamil Nadu Agricultural University,  
Coimbatore- 641 003  
INDIA

D. Manohar Jesudas  
Professor and Head  
Department of Farm Machinery,  
Agricultural Engineering College  
& Research Institute,  
Tamil Nadu Agricultural University,  
Coimbatore- 641 003  
INDIA

## Abstract

The power weeder is a multi-purpose hand tractor designed primarily for intercultural operations. The operator's environment includes all the factors in the surroundings, which have an effect on the man-machine system. Among these factors, mechanical vibration is more important as it significantly accelerates fatigue and affects sensitivity and reaction rates of the operator. This paper deals with machine vibration, hand transmitted vibration (HTV) of selected power weeders (TNAU-Varun power weeder, Balram power weeder and Oleo power weeder) during weeding operation in a cotton crop at 1.5, 1.8 and 2.1 km h<sup>-1</sup> forward speeds. The HTV was measured and analyzed as per the guidelines of International Standards ISO 5349 (1986). Vibration was measured using a portable four-channel multi-analyzer system (Bruel and Kjaer Type 3560 C). The increase in engine speed from

1,600 to 3,200 rpm resulted in three fold increase in peak acceleration at the handle of all the three power weeders. Vibration at the top of the engine was the highest followed by handle, gear box, chassis and root of the handle in all the three selected power weeders. The exposure time to HTV was limited to 1/2 to 1 h with increase in speed from 1.5 and 1.8 km h<sup>-1</sup>, further increase in speed to 2.1 km h<sup>-1</sup> reduced the limit to < 1/2 h, respectively, for all the three power weeders. Vibration isolators made of Steryl butadiene rubber were developed. Four isolators were mounted between the chassis and engine. The isolator for the handle was incorporated by cutting the handle bar near the handle grip portion. Provision of vibration isolators resulted in the reduction of peak value of r.m.s acceleration by 21.9 to 25.5 percent for the TNAU-Varun power weeder, 15.5 to 21.1 percent for the Oleo power weeder and 8.2 to 14.8 percent for the Balram power weeder, respectively, with the

increase in forward speed from 1.5 to 2.1 km h<sup>-1</sup>. Provision of vibration isolators increased the exposure limit to 1-2 h for the TNAU- Varun and Oleo power weeders at 1.5 and 1.8 km h<sup>-1</sup> of forward speed.

## Introduction

Weed control is one of the most expensive operations in crop production. Hand weeding requires more labour and consumes more time leading to higher cost of weeding. Hence inter-cultivation of weeds using mechanical power is a viable and economical solution for this problem. Though tractors have been in our country for over four decades. Until now, there has been no visible change in the scenario of inter-cultivation practices in the mechanized farm. The reasons are many including the initial cost of the tractor and the traditional cropping pattern and layout. Power weeders have been developed for



the mechanical control of weeds. The ergonomics aspects of power weeder are of great importance as working with a power weeder involves considerable physical strain to the operator. Hand-transmitted vibration of a power weeder is very strong since the handle grip of a walking tractor is a cantilever beam, and the power is obtained from a single cylinder diesel engine (Ying *et al.*, 1998). Daily exposure to hand-arm vibrations over a number of years can cause permanent physical damage known as 'white finger syndrome' or it can damage the joints and muscles of the wrist and the elbow. White finger syndrome in its advanced stages is characterized by blanching of the extremities of the fingers, which is caused by damage to the arteries and nerves in the soft tissues of the hand. Measurement and evaluation of vibrations are necessary for assessing operator comfort and for suggesting limits for the continuous operation of power weeders. Thus, this paper deals with the measurement of machine vibration and HTV at the handle grip level for different forward speeds during weeding operations.

## Review of Literature

Araya (1986) reported that handle vibration in hand operated tilling machines was mainly due to the reciprocating motion of the main moving parts. Jiao Qunying *et al.* (1989) concluded that the major excitations of the hand transmitted vibration of a walking tractor were the unbalanced inertia force of the engine and the unevenness of road surface. He also reported that the hand transmitted vibration caused by the unevenness of road makes up about 20 percent of the total transmitted vibration of the walking tractor (Jiao Qunying *et al.*, 1993).

## Materials and Methods

The power weeders selected for the investigations were the TNAU-Varun power weeder (PW<sub>1</sub>), Balram power weeder (PW<sub>2</sub>) and Oleo power weeder (PW<sub>3</sub>). The TNAU-Varun power weeder (PW<sub>1</sub>) consisted of a 7.5 kW diesel engine, power transmission housing, ground wheels, rotary knives, handle and clutch. From the engine, the power was transmitted to the transmission housing and then to the ground wheels and rotary knives. The knives, when rotating, enabled weeding and mulching the soil. Width of the rotary was 550 mm and depth of weeding could be adjusted. The Balram power weeder consisted of a 4 kW petrol start kerosene run engine, power transmission housing, rotary knives, handle and clutch. There was provision to adjust ground wheel spacing according to the row crop spacing. A clutch with lever provided at the handle actuated a simple idler pulley and disengaged the power transmission from the engine to rotary tynes. These knives, when rotating, enabled weeding and mulching of the soil. Width of the rotary was 350 mm and depth of weeding could be adjusted. The Oleo power weeder was a compact and lightweight machine (4.2 kW petrol engine) ideal for working with ease even in confined spaces. A front wheel with vertical tip-up mechanism was provided for easy transport and could be lifted to facilitate tillage work. Two sided protection discs ensured that crops remain undamaged while also maximizing operator safety. The transmission guard was reinforced to withstand projected stones and accidental impact.

### Instrument for Measuring Vibration and Noise

The machine vibration, human vibration and noise of the power weeders were measured and analyzed using the portable PULSE multi-analyzer system (Brüel &

Kjaer Type 3560 C). The transducer used for vibration measurements was the piezoelectric accelerometer. It exhibited better all round characteristics and stability than any other type of vibration transducer and its response was linear through the frequency range of interest in human vibration measurements. The mass of the accelerometer should not exceed one tenth of the vibrating part (Harris and Crede, 1976 and Brüel and Kjaer, 1982). The PULSE multi-analyzer system was a versatile, task oriented analysis system for vibration and noise analysis. It provided the platform for a range of PC based measurement solutions. Type 3560 C was a portable system powered by internal batteries or an external DC supply (Fig. 1). The base software for a PULSE system was vibration and noise analysis type 7700. The instrument set up for the measurement of vibration of the power weeder is shown in Fig. 2.

### Measurement of Hand Transmitted Vibration

The power weeder was put in proper test condition before conducting the experiments, that is, in full working order with full fuel tank and radiator, without optional front weights, tire ballast and any other specialized components. Tires used for the tests were of standard size and depth of treads was not less than 70 percent of the depth of a new thread. Pneumatic wheels with recommended tyre pressure were used during weeding operations. There were no known mechanical defects that would result in abnormal vibration in power weeders. The vibration from the handle of the power weeder was transmitted to the hand and arm of the operator through the palm of his hand. The hand transmitted vibration was measured at handle-grip level as per the guide lines issued in ISO 5349 (1986). The transducer employed was a piezoelectric accelerometer (B&K, Type 4392) mounted on

a hand adapter to insert between the fingers and the grip (Ying *et al.*, 1998 and Ragni *et al.*, 1999) and fixed on the grip by tape. The transducer was inserted between the middle and index fingers of left hand of each subject since the force output from index and middle finger (**Fig. 3**) was larger than that from the ring and little finger (Fransson and Winkel, 1991). The orientation of the measurement axes of the accelerometers were according to ISO 5349 (1986). The Z-axis was directed along the second metacarpus bone of the hand, the X-axis was perpendicular to the Z-axis (both these axes were normal to the longitudinal axis of the grip) and the Y-axis was parallel to the longitudinal axis of the grip.

The experiments were conducted during 30 and 60 DAS. The depth of operation was maintained at a constant level of about 10 cm during rototilling. The subjects were instructed to hold the handle grip with a light and constant compression force. The hand transmitted vibration was measured for power weeders during the weeding operation in a cotton field. Measurements were carried out at selected levels of forward speed of the power weeder for weeding operations. The speedometer was monitored continuously to ensure constant forward speed

selected during each trial. Measurements were made at different forward speeds, viz., 1.5 km h<sup>-1</sup>, 1.8 km h<sup>-1</sup> and 2.1 km h<sup>-1</sup> during field trials. The PULSE Programme was activated after the power weeder was started for the operation and the measurement was recorded with an acquisition period of 60 seconds (Ying *et al.*, 1998). Each trial was repeated five times for all operating conditions. The same procedure was repeated for all the selected subjects.

## Results and Discussion

The vibration of the TNAU Varun power weeder, Balram and Oleo power weeders was evaluated in terms of machine vibration in stationary mode and hand transmitted vibration in weeding operation mode. Machine vibration at different locations on the power weeder in stationary condition as well as hand transmitted vibration under operating conditions in the field were measured and recorded.

### Machine Vibrations in Stationary Mode

The values of peak acceleration arrived from the vibration spectrum for the selected power weeders at different engine speeds are fur-

nished in **Table 1**. It was observed that as the engine speed increased, the peak acceleration also increased at different locations for all the three power weeders. Since the major vibration contribution was the power stroke of the engine, as the engine speed increased more power strokes were completed per second and the different components of the power weeder vibrated more frequently and resulted in higher values of acceleration. The increase in engine speed from 1,600 to 3,200 rpm resulted in three fold increase in peak acceleration at the handle of the TNAU-Varun and two fold increases for the Oleo and Balram power weeders. Comparing the acceleration at different locations of the power weeder, the vibration at the top of the engine was the highest followed by handle, gear box, chassis and root of handle. The vibration at the top of the engine was

**Fig. 1** PULSE multi-analyzer system

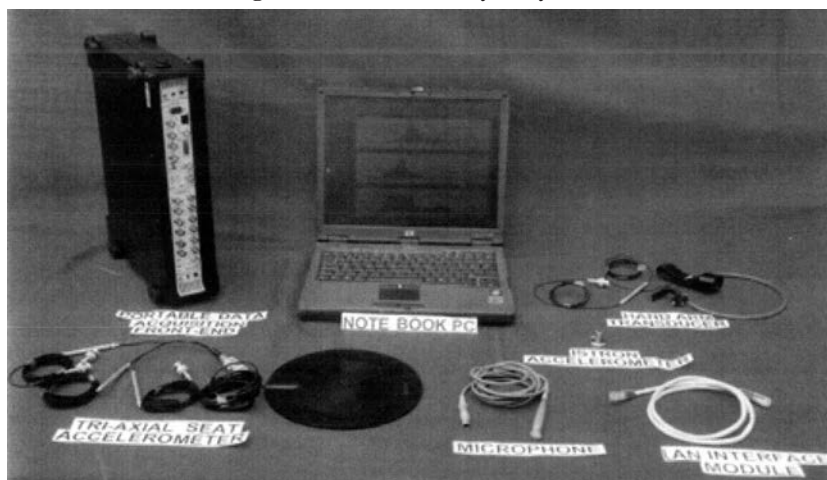

**Fig. 2** Instrument set up in power weeder

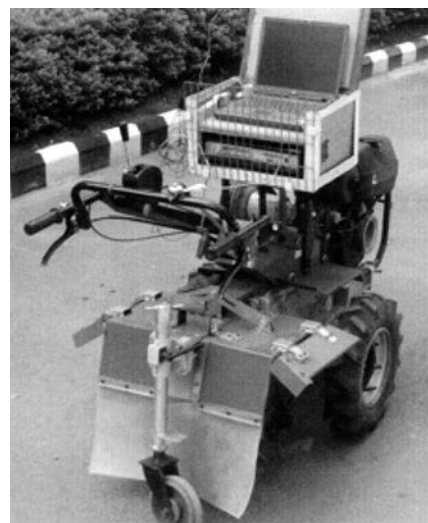

**Fig. 3** Hand arm transducer



the highest since the major excitation of the vibration of the power weeder was the unbalanced inertia force of the engine (Jiao Qunying *et al.*, 1989; Dong, 1996 and Ying *et al.*, 1998). Among the three power

weeders, the vibration induced at selected locations was maximum for the Balram power weeder followed by the Oleo and TNAU-Varun power weeders. This might have been due to the damping effect of rub-

ber tire in the TNAU-Varun power which was absent in the Balram and Oleo power weeders.

### Vibration Characteristics in the Weeding Operation

The peak value of acceleration from the vibration spectrum for the selected power weeders at selected levels of forward speed for first and second weeding operations are furnished in **Table 2**.

The magnitude of acceleration on the handle increased with increase in selected levels of forward speed for both first and second weeding operations. It was evident that peak acceleration on the handle was higher in first weeding than the second weeding. Since the field was relatively compact during first weeding as compared to second weeding, the damping effect was less in weeded field. Acceleration between handle vibrations was higher for Balram power weeder than Oleo and TNAU-Varun power weeder for weeding on 30 and 60 DAS.

### Hand Transmitted Vibration (HTV)

The HTV of the selected power weeders was assessed in terms of safe exposure limit and latent period, or duration of exposure necessary before the onset of vascular symptoms characterized by finger blanching for 10 percentiles of an exposed population. As per the guidelines in ISO 5349 (1986), hand transmitted vibration should be evaluated in the direction of the most serious vibration. Hence, in this investigation it was evaluated in the x direction (Ikeda *et al.*, 1998). The mean values of r.m.s weighted acceleration (HTV) for all the subjects at selected levels of forward speed for the three power weeders during the first and weeding are furnished in **Table 3**.

### Vibration Isolators

From the predicted exposure limit of the subjects for the measured values of HTV, the safe exposure time

**Table 1** Machine vibrations of power weeders in stationary mode

Engine speed, rpm	Peak acceleration, ms <sup>-2</sup>				
	Engine top	Chassis	Gear box	Root of handle bar	Handle
<b>TNAU-Varun power weeder</b>					
1600	7.45	4.30	3.80	2.10	6.21
1900	9.79	6.12	4.11	4.22	9.65
2200	11.45	7.56	5.20	5.41	11.10
2500	13.02	9.54	6.78	6.54	12.10
2700	15.41	11.78	8.12	7.89	15.25
3000	18.11	14.23	9.51	9.22	17.45
3200	20.18	16.25	11.23	10.21	19.23
<b>Oleo power weeder</b>					
1600	13.75	5.30	-	2.14	10.01
1900	15.21	6.89	-	3.47	13.41
2200	18.54	7.76	-	5.26	16.12
2500	19.45	8.21	-	7.81	17.45
2700	20.15	10.11	-	11.58	19.48
3000	21.32	11.48	-	13.45	21.11
3200	22.47	13.21	-	13.97	22.65
<b>Balram power weeder</b>					
1600	16.93	8.65	3.60	3.20	12.40
1900	18.71	9.97	5.47	5.34	16.53
2200	21.53	10.89	7.99	7.02	19.63
2500	22.84	12.05	11.75	10.36	20.61
2700	23.38	13.89	14.71	13.94	22.10
3000	24.80	15.21	17.51	15.32	23.47
3300	26.13	16.30	19.81	16.40	24.40
3600	27.10	17.40	21.50	17.50	25.10

**Table 2** Machine vibrations of power weeders during weeding

Forward speed, km h <sup>-1</sup>	Peak acceleration on handle, ms <sup>-2</sup>	
	Weeding on 30 DAS	Weeding on 60 DAS
<b>TNAU-Varun power weeder</b>		
1.5	5.48	4.10
1.8	6.11	6.50
2.1	7.59	7.98
<b>Oleo power weeder</b>		
1.5	6.09	6.24
1.8	7.44	6.97
2.1	9.79	7.51
<b>Balram power weeder</b>		
1.5	10.43	10.45
1.8	12.25	12.35
2.1	14.63	15.31

limit for hand transmitted vibration of the selected power weeders was of serious concern, restricting the safe exposure to < 1/2-1-2 h in weeding. On an average, power weeders were used for more than 5 h per day. If the subjects were exposed to 5 h at this level of HTV, the prevalence of vibration-induced white finger (VWF) and numbness of the hands would start much earlier. Hence, in order to increase the exposure time, the HTV of the power weeder needs to be reduced. The vibration at the handle can be reduced by providing vibration isolators.

### Vibration Isolators for Engine

In power weeders, the major source of vibration was the unbalanced inertia force of the engine. The vibration from the engine was transmitted to the handle through the chassis, gear box and handle bar. Four vibration isolators (made of Steryl butadiene rubber) were mounted between the engine and chassis (**Fig. 4**).

The probability of occurrence of white finger syndrome for 10 percentile of an exposed population was reduced by 14.5 to 18.7 percent for the TNAU-Varun power weeder, 9.5 to 24.2 percent for the Oleo pow-

er weeder and 3.2 to 21.0 percent for the Balram power weeder with an increase in forward speed from 1.5 to 2.1 km h<sup>-1</sup> after incorporating the vibration isolators.

### Conclusion

The increase in engine speed from 1600 to 3200 rpm resulted in three fold increase in peak acceleration at the handle of the TNAU- Varun and two fold increase for the Oleo and Balram power weeders. Vibration at the top of the engine was the highest followed by handle, gear box, chas-

**Table 3** Hand transmitted vibration of power weeders during weeding

Forward speed, km h <sup>-1</sup>	Mean value of root mean square acceleration, ms <sup>-2</sup>		Exposure time, h		Probability of white finger syndrome, years	
	Weeding on 30 DAS	Weeding on 60 DAS	Weeding on 30 DAS	Weeding on 60 DAS	Weeding on 30 DAS	Weeding on 60 DAS
<b>TNAU-Varun power weeder</b>						
1.5	3.52	3.38	1/2-1	1/2-1	6.08	6.25
1.8	3.92	3.77	1/2-1	1/2-1	5.60	5.77
2.1	4.99	4.51	< 1/2	< 1/2	4.28	4.74
<b>Oleo power weeder</b>						
1.5	3.65	3.52	1/2-1	1/2-1	5.92	6.08
1.8	4.25	4.15	1/2-1	1/2-1	4.94	5.06
2.1	5.07	4.63	< 1/2	< 1/2	3.94	4.48
<b>Balram power weeder</b>						
1.5	3.78	3.58	1/2-1	1/2-1	5.76	6.01
1.8	4.72	4.36	1/2-1	1/2-1	4.46	5.05
2.1	5.26	4.99	< 1/2	< 1/2	3.80	4.28

**Table 4** Hand transmitted vibration during weeding with vibration isolators

Forward speed, km h <sup>-1</sup>	Root mean square acceleration, ms <sup>-2</sup>	Exposure time, h	Probability of white finger syndrome, years
<b>TNAU-Varun power weeder</b>			
1.5	2.64 (3.38)	1-2 (1/2-1)	7.31 (6.25)
1.8	2.81 (3.77)	1-2 (1/2-1)	6.81 (5.77)
2.1	3.56 (4.51)	1/2-1 (< 1/2)	5.83 (4.74)
<b>Oleo power weeder</b>			
1.5	2.89 (3.42)	1-2 (1/2-1)	6.72 (6.08)
1.8	3.16 (4.15)	1-2 (1/2-1)	6.03 (5.06)
2.1	3.47 (4.63)	1/2-1 (< 1/2)	5.91 (4.48)
<b>Balram power weeder</b>			
1.5	3.23 (3.52)	1/2-1 (1/2-1)	6.21 (6.01)
1.8	3.74 (4.36)	1/2-1 (1/2-1)	5.63 (5.05)
2.1	4.25 (4.99)	1/2-1 (< 1/2)	5.42 (4.28)

(The figures in parentheses are the values of peak acceleration without isolators)

**Fig.4** Vibration isolators fitted in power weeders

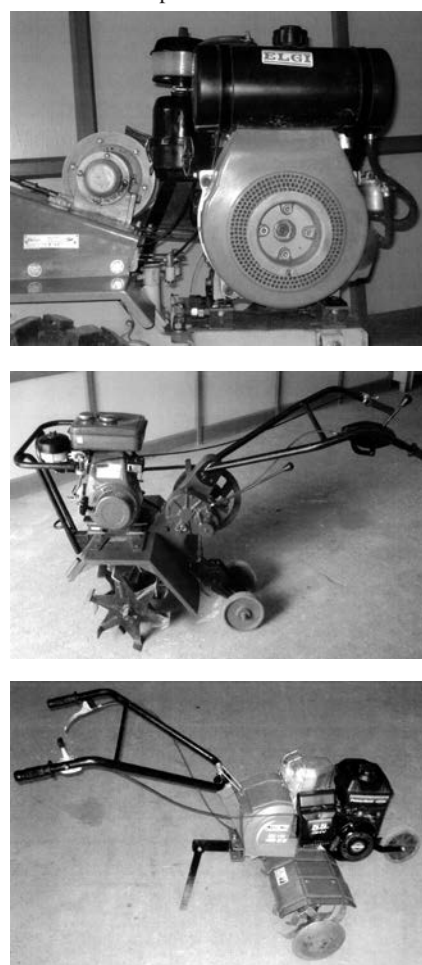

sis and root of handle in all the three selected power weeders. Among the three power weeders, the vibration induced at selected locations was maximum for the Balram power weeder followed by the Oleo and TNAU-Varun power weeders. The exposure time for HTV was limited to 1/2 to 1 h with increase in speed from of 1.5 and 1.8 km h<sup>-1</sup>. Further increase in speed to 2.1 km h<sup>-1</sup> reduced the limit to < 1/2 h for all the three power weeders. Provision for vibration isolators increased the exposure limit to 1-2 h for the TNAU-Varun and Oleo power weeders at 1.5 and 1.8 km h<sup>-1</sup> forward speed.

## REFERENCES

- Ying Y., L. Zhang, F. Xu, and M. Dong. 1998. Vibratory characteristics and hand transmitted vibration reduction of walking tractors. *Transactions of the ASAE*. 41(4): 917-922.
- Majumder, B. 1994. Vibration and noise characteristics of a Thai-made power tiller. Unpublished ME Thesis, Asian Institute of Technology, Bangkok, Thailand.
- Jiao, Qunying, Qianhua Wang, Kuifu Chen, and Daxing Zhao. 1993. The excitations and characteristics of the vibration of walking tractor handle using isolators. *Transactions of the Chinese Society of Agricultural Machinery* 24(4): 74-79.
- Ragni, L., G. Vassalini, F. Xu, and L. B. Zhang. 1999. Vibration and noise of small implements for soil tillage. *Journal of Agricultural Engineering Research* 74: 403-409.
- Fransson, C. and J. Winkel. 1991. Hand strength: the influence of grip span and grip type. *Ergonomics* 34(7): 881-882.
- Dong, M. D. 1996. Testing analysis and evaluation of vibration transmitted by handles of GN-5 walking tractor. *Journal of Zhejiang Agricultural University* 22(1): 68-72.

■ ■

# Study of the Mechanics of a 5 HP Power Tiller Attached to a 10-Row Garlic Planter

by  
Jiraporn Benjaphragairat  
Associate professor  
Agricultural Engineering Department,  
Faculty of Engineering,  
King Mongkut's  
Institute of Technology Lardkabung,  
Bangkok, 10520 THAILAND  
kbjirapo@gmail.com



Hai Sakurai  
JICA Expert, Chief Advisor,  
Agriculture Machinery Centre (AMC),  
Ministry of Agriculture,  
Royal Government of Bhutan  
BHUTAN  
sakurai@druknet.bt

Nobutaka Ito  
Professor  
Director of Center for International Student  
Faculty of Bio-Resource, Mie University,  
JAPAN  
Ito-no@bio.mie-u.ac.jp

## Abstract

This project was an experimental study of the mechanics of a 5-HP power tiller with a 10-row garlic planter attached. Statistical analysis of the equilibrium of the power tiller with the 10-row garlic planter attachment was taken into consideration. The position of the center of mass and all applied forces were also evaluated. Consideration of the dynamics was taken into account to refine the equilibrium of all applied forces as the weight of garlic was gradually reduced during operation. A computer programme (in the C++ language) was written to analyze the handle by changing the position of the engine and varying the handle length.

## Introduction

Garlic is an important cash crop, with the bulbs being used, not only for cooking in nearly every kitchen,

but also as medical herbs. Large quantities of garlic are grown in China, South Korea and India. In Thailand, the area planted with garlic is about 24,000-34,000 ha, producing some 9,000 metric tons/year. The average yield for fresh garlic is 10.7-11.9 metric tons per hectare (online, <http://www.oae.go.th>). The problem of such a low yield is found in the farming method. It is labour intensive and, thus, garlic planting is expensive. The farmer must prepare the soil within a limited timeframe in order for there to be enough moisture for planting. This necessitates a large amount of manpower for planting before the soil dries up.

Mechanisation appeared to be a good solution to the manpower problem and, with this concept in mind, a machine was developed for garlic planting in 1999. The principle was to design a machine that was practical to use, easy to repair and maintain and that could be manufactured and sold at a cost that farmers could

afford. Such a planter was required to plant with a high degree of accuracy. The intention was to use mainly domestic technology to build and maintain the machine. In 2001, the first prototype, a 10-row garlic planter, was introduced for a farmer trial and evaluation in Chiangmai province.

There were two methods of land preparation for garlic cultivation in Chiangmai province. raised bed, 20 %, and unraised bed, 80 %. For raised bed preparation, the farmer plowed one time with a rotary tiller. For unraised the farmer planted after rice harvesting; there was no plowing; only irrigation of the area to be planted until the soil was saturated and then the garlic was planted. The planting capacity was very low; about 0.05 ha/man-day. Farmers faced the problem of a labour shortage during planting season. For a cultivated area higher than 0.32 ha, a farmer would require a large labour force for planting. Labour must be hired for 220-250

baht/man/day.

The prototype planter worked well under real garlic field conditions, and the farmer was satisfied with the output (Jiraporn, 2002). However, some problems were experienced. In particular, there was the accuracy of the required 10 cm plant spacing and the ability to turn the planter at the headland. This was due to the 205 kg weight of the prototype, and the fact that the 5 HP power tiller produced in Thailand had no steering clutch. Hence, this latter problem caused overloading of the planter and increased slipping, further reducing maneuverability. Although the operator was able to work the prototype planter, albeit with difficulty, it was with low capacity.

The study of the mechanics of the 5 HP power tiller with the attached 10-row garlic planter were carefully researched to solve those problems mentioned above. The overall objective of the study was, therefore, to develop: a) the motion characteristics and the design principle for balancing the conditions of the 5 HP power tiller with the 10-row garlic planter; b) calculate the results, using c++ programming language, and c) to investigate the cause of incorrect clove spacing and find a

solution to improve the precision of spacing without affecting the seed metering device position.

## Materials and Methods

### Force Analysis Acting on a 5 Hp Power Tiller with the 10-Row Garlic Planter

Fig. 1 illustrates the force acting on the 10-row garlic planter attached with a 5 HP power tiller (Bager *et al.*, 1963). The balancing eqns are shown below.

The horizontal balance of the machine is

$$P_g + F_H - F_C - R_H - F_D = 0,$$

and the vertical balance of the machine is

$$W_1 + W_2 + W_3 + R_V - R_1 - R_2 - F_V = 0.$$

The moment balance about the point C under the wheel axle center is required. The handle force can be determined by the following eqn..

$$F_V X_6 + R_V X_4 + W_2 X_2 + W_3 X_3 = R_2 X_5 + W_1 X_1$$

The weight of the engine, the body of the power tiller and the garlic planter, were determined by conventional weighing methods. The center of mass were found by suspension and weighing methods (Barger *et al.*, 1963). The distance

between the internal and external forces and the center of moment were measured.

### The Center of Mass Methods

The center of mass was obtained by the methods of weighing and suspension (Barger *et al.*, 1963) as shown in Figs. 2-4.

Parameters on the moment balance eqn. are defined as follow:

$W_1$  = Weight of engine, 24.8 kg

$W_2$  = Weight of the body of the 5 HP power tiller, 68.75 kg

$W_3$  = Weight of the 10 row garlic planter, 58 kg

$R_1$  = Soil resistance at driven wheels, 64 kgf

$R_2$  = Soil resistance at supported wheels, 78.5 kgf

$R_V$  = Vertical forces at the openers, ~0 kgf

$F_V$  = Vertical forces at handle, kgf

$X_1$  = 12.75 cm

$X_2$  = 12.82 cm

$X_3$  = 50.00 cm

$X_4$  = 77.00 cm

$X_5$  = 30.20 cm

$X_6$  = 1000.00 cm

### Programming Design

This program was composed of 3 parts: (a) program for the center of mass, (b) program for calculation of the handle force and (c) program of balancing. Each program was used as shown Fig. 5.

Fig. 1 Diagram of the external and internal forces acting on the 5 HP power tiller and the attached 10-row garlic planter

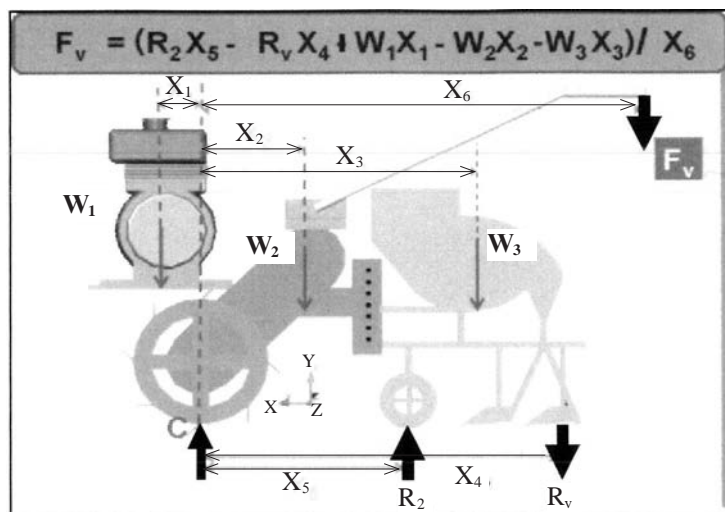

## Results and Discussion

### Results of Handle Forces from the Computer Program

A computer programming was used to analyze the engine position and the handle length. The suitable handle force for operators ranged between 15-25 kg (Yanyeng, 2003). The handle force of the prototype was 46 kgf, which was very heavy for the operator and the handle length at 1.00 m was too close for the operator. These problems caused inconvenience during the operation of the prototype. Hence,

**Fig. 2** Determining the center of mass for the 10-row garlic planter using suspension methods

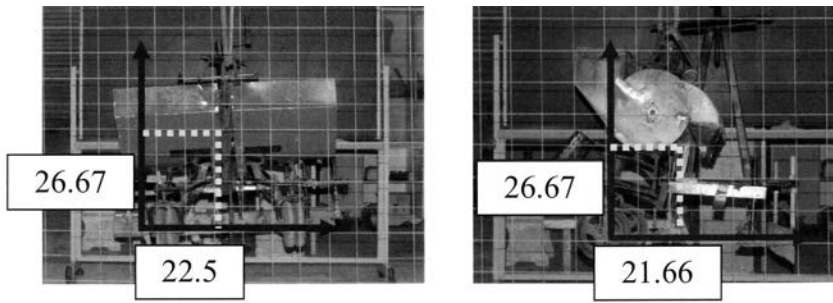

**Fig. 3** Determining the center of mass for the engine by suspension methods

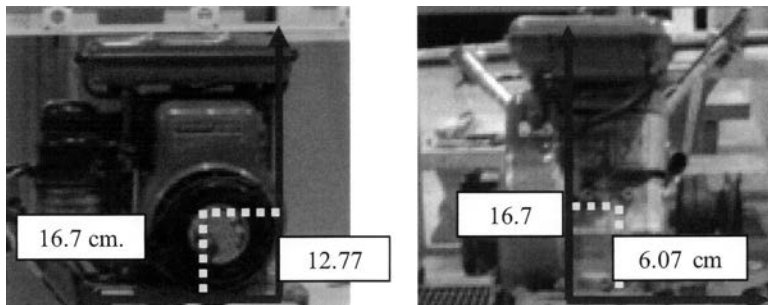

**Fig. 4** Determining the center of mass for the 5 hp power tiller without engine by weighing methods

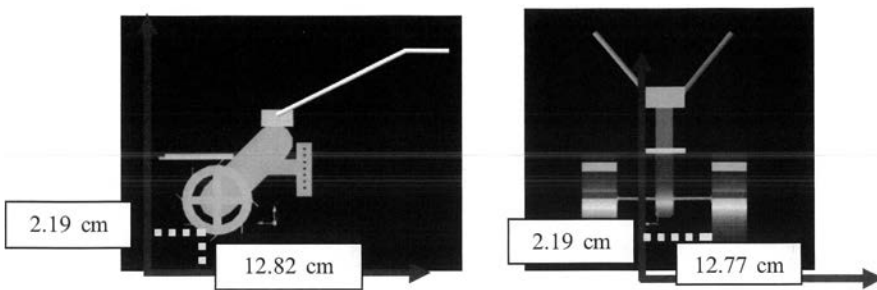

**Fig. 5** Flow diagram of the program design for determining the center of gravity, the handle force and balancing

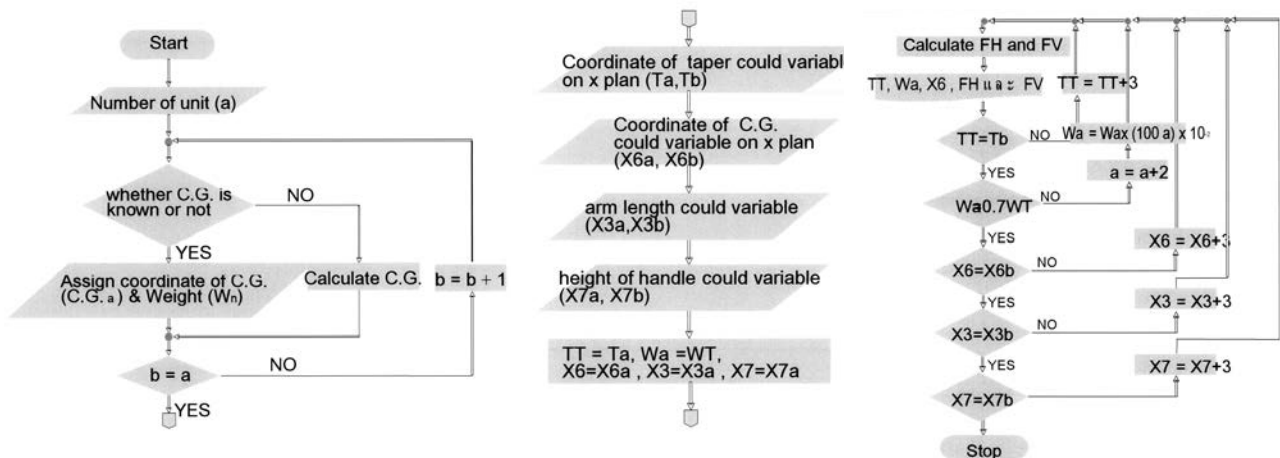

modification of the engine distance and handle length that did not affect the metering system position were necessary. The force results of the adjusted engine distance are presented in **Fig. 6**. The relationship between the engine distance and the handle force are shown as a straight line (**Fig. 7**). However, the relationship between the handle force and the handle length is shown as a parabolic curve where it can be seen that the handle force is suddenly reduced when the handle length is increased from 1.00-2.00 m. The suitable force and an average Thai normal footstep are 15-25 kg (Yanyeng, 2003) and 0.80 m, respectively. The range of the engine distance and handle length were selected as 0.5-0.6 m and 1.6-1.7 m, respectively. The results of the force calculation are presented in **Table 1**. The results from the computer program showed that increasing the engine distance and the handle length resulted in a reduction of handle force. These changes should, therefore, be implemented to improve the output and convenience of the operation. Results of the test from the experimental field area confirmed that increasing the handle length reduced both the turning time and the turning radius. An engine distance longer than 55 cm increased both the



turning time and the turning radius. This was because the operation was more difficult.

**Operator’s Opinion after Working with the 5 HP Power Tiller with the Attached 10-Row Garlic Planter**

The experiments were conducted in the institute’s field areas. Ten female operator opinions were recorded for five levels (cannot operate, very heavy, medium, light and very light). The 10-row garlic planter with an engine distance of 10 cm and a handle length of 100 cm was tested and compared with the

new prototype against three levels of engine distance (0.50, 0.55 and 0.60 m) and three levels of handle length (1.60, 1.65 and 1.70 m). Both prototype garlic planters, operated at a forward speed of 1.68 km/h. The opinions of the operators were recorded during footsteps and turning. Three replications were used. The best performance for the turning radius and the turning time were 73.6 cm and 4.44 s, respectively. As shown in **Table 2**, the optimum engine distance and handle length were 0.50 m and 1.70 m, respectively. The handle force was reduced

from 46 kg to 20 kg. The average turning time and turning radius were 4.4 s and 0.74 m, respectively. The opinion of the operators was ‘very light’ during walking and turning at the headland.

**Forces Analysis for the Weight Balance on the 5 HP Power Tiller with the Attached 10-Row Garlic Planter**

The hopper was filled with 15 kg of garlic cloves. The best performance of garlic planter (Jiraporn, 2002) was when operated in gear I at an engine rpm of 1,100, 1,300 and 1,400 and a forward speed 1.3-

**Fig. 6** Shows the relationship between the engine distance and the handle force

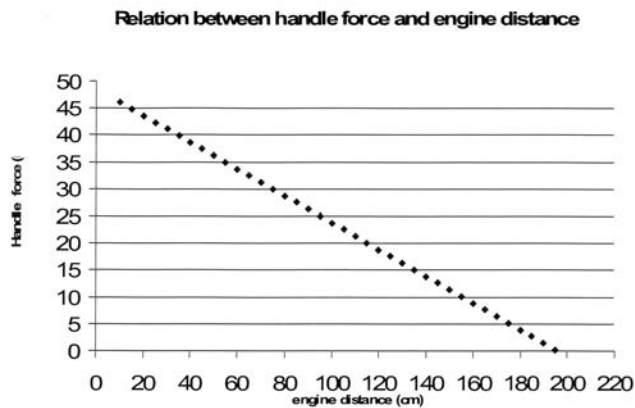

**Fig. 7** Shows the relationship between the handle length and the handle force

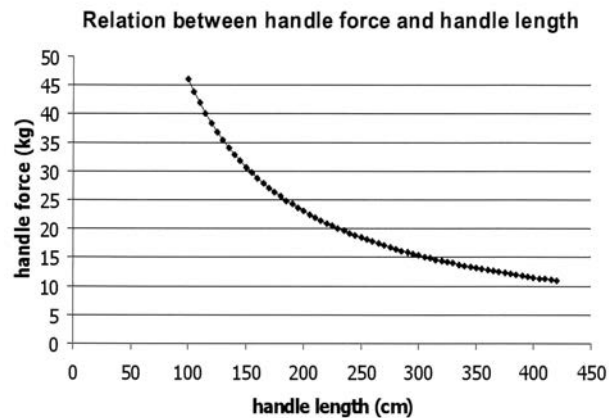

**Table 1** The handle force results from the computer program when the engine distance range was 0.5-0.6 m and the handle length range was 1.6-1.7 m

Engine distance, m	Handle length, m	Handle force, kg
0.50	1.60	22.61
	1.65	21.92
	1.70	21.28
0.55	1.60	21.83
	1.65	21.17
	1.70	20.55
0.60	1.60	20.43
	1.65	19.82
	1.70	19.25

**Table 2** Results of the experiment in the field area

Engine distance, m	Handle length, m	Turning radius, m	Turning time, sec	Operators’ opinions
0.10	1.00	2.81	11.58	Very heavy
	1.60	2.48	8.34	Medium
	1.65	1.93	7.99	Medium
	1.70	1.59	6.69	Light
0.50	1.00	1.46	7.19	Very heavy
	1.60	1.08	55.60	Medium
	1.65	0.95	5.67	Light
	1.70	0.74	4.44	Very light
0.55	1.00	1.76	7.02	Very heavy
	1.60	1.40	6.16	Medium
	1.65	1.22	5.28	Medium
	1.70	1.15	5.27	Medium
0.60	1.00	1.30	4.83	Medium
	1.60	1.15	5.05	Medium
	1.65	1.14	5.16	Light
	1.70	0.99	4.48	Light

1.4 km/h, with the disc between 35-41 rpm and an average garlic cloves spacing of 10.21 cm (shown in **Table 3**). The garlic cloves were released into the soil furrow at an average rate of 3 kg/min and the force balance at the handle was controlled to maintain stability at 20 kgf.

An additional weight of 10 kg ( $W_i$ ) (**Fig. 8**) had to be installed at distance ( $X_i$ ) ( $X_i$  being the distance between the additional weight and the centre of moment) of 50 cm when the garlic hopper was full. While decreasing the garlic cloves at the rate of 3 kg/min until the hopper was empty, distance  $X_i$  was reduced in relation to the seed rate. Distance ( $X_i$ ), was adjusted from the beginning position of 50 cm to 42, 36, 28, 20 and 12 cm, respectively.

## REFERENCES

Barger, E. L. *et al.* 1963. Tractors and Their Power Units. 2nd Ed., John Wiley & Sons, Inc. U.S.A.  
 Hunt, D. 1995. Farm Power and Machinery Management. 9th Ed., Library of Congress Cataloging in Publication Data. 112-114: 263-268.  
 International Organization for Stan-

ardization. 1984. Sowing Equipment-Test Methods-Part 1. Single Seed Drills (Precision Drills). 7256/1.

Benjaphragairat, J. *et al.* 2002. Final report. Design and development of a garlic planter attached to 5 HP power tiller. Department of Agricultural Engineering, Faculty of Engineering, King Mongkut's Institute of Technology Ladkrabang, Thailand. (Mineographed).

Klennin, N. I., I. F. Popov, and V. A. Sakun. 1986. Agricultural Machines Printing Work, New Delhi:

129-158

Mohsenin, N. N. 1980. Physical Properties of Plant and Animal Materials. Gordon and Breach, Science Publisher, Inc. 579

Srivastava, A. K., C. E. Goering, and R. P. Rohrbach. 1994. Engineering Principles of Agricultural Machines. ASAE Textbook No. 6. American Society of Agricultural Engineers. St. Joseph, Michigan.

[Online]. Available: <http://www.oae.go.th/statistic/yerbook/2001-04>.

■ ■

**Fig. 8** Balancing forces including the 10 kg weight transfer ( $W_i$ )

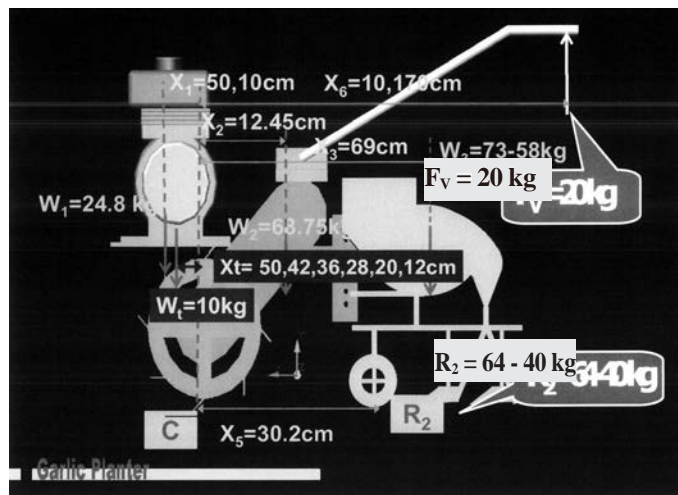

**Table 3** Garlic rate at various engine revolutions (with an engine distance of 0.50 m and a handle length of 1.70 m with small buckets and medium sized garlic cloves of the native variety)

Engine revolution (rpm) in Gear I	Disc revolution, rpm	Cloves Spacing, cm	Percentage of cloves spacing, %	Forward speed, km/h	Garlic rate, kg/min
800	25	11.76	36.55	0.92	1.45
1,100	36	10.58	33.54	1.30	2.40
1,300	37	10.30	37.04	1.33	3.32
1,400	41	9.71	36.86	1.48	3.13
1,700	46	10.15	37.61	1.67	3.98
2,000	62	9.20	24.61	2.24	5.42

Engine revolution (rpm) in Gear I	Disc revolution, rpm	Number of samples	Standard deviation, %	Multiple Index, %	Miss Index, %	Quality of feed Index, %	Precision, %
800	25	145	7.19	20.69	22.76	56.55	28.10
1,100	36	161	6.80	27.33	21.74	50.93	27.30
1,300	37	108	5.81	21.30	17.59	61.11	29.50
1,400	41	236	6.15	28.81	15.25	55.93	27.60
1,700	46	218	6.58	27.06	15.60	57.34	27.20
2,000	62	317	7.56	39.12	17.35	43.43	27.20

# Air-jet Seed Knockout Device for Pneumatic Precision Planters



by  
Hassan Zaki Dizaji  
Ph.D. Student  
Agricultural Machinery Engineering Department,  
Tarbiat Modares University, Tehran,  
IRAN  
zakih@modares.ac.ir



Saeid Minaei  
Associate Professor  
Agricultural Machinery Engineering Department,  
Faculty of Agriculture,  
Tarbiat Modares University,  
P. O. Box: 14115-336, Tehran,  
IRAN

Mohammad Reza Y. Taheri  
Scientific Member  
East Azerbaijan Research Center  
for Agriculture & Natural Resources,  
Tabriz,  
IRAN

## Abstract

One of the important applications of pneumatic systems is in seed planting machines. A seed knockout device is one of the main components of precision-pneumatic planters for sowing small seeds. Examination of various commonplace plate-type vacuum planters shows that the main reason for low success of plate-type vacuum planters in planting small seeds is the current deficiency in their seed metering mechanism. On the other hand, studies on seed ejection by seed knockout devices are very limited. Therefore, the main objective of the present research is studying seed ejection by a seed knockout mechanism for improving the available plate-type vacuum planters. First, the effective parameters in seed ejection were determined theoretically, then an air-jet seed knockout device was developed and mounted on the seed metering device of a vacuum-precision planter. Subse-

quently, the influence of effective parameters in seed ejection and that of the knockout device on the planter's performance was tested. Important, effective parameters in seed ejection are the rotational velocity of the seed plate, the air velocity of the air-jet seed knockout device, and the distance of the nozzle tip from the seed plate holes. Independent test variables were rotational velocity of the seed plate at three levels (40, 68 and 99 rpm) and air velocity of the air-jet seed knockout device at three levels (0, 7-8 and 15-16 m/s). Dependent variables included three different types of seed damage, cell filling percentage, and seed viability. Analysis of variance indicated that mechanical damage decreased with increasing air velocity. Test results indicated that, not only did the air-jet seed knockout device decrease seed damage, but also, due to clearing the seed metering plate of cells clogged by broken seeds and plant debris, it increased cell filling percentage and improved overall

performance of the seed metering system.

## Introduction

In an air-jet seed knockout device, air flow is jetted towards the back of the seed plate holes where the seed is captured within the hole. The air stream from the nozzle dislodges and ejects the captured seed towards the ground. Advantages of air-jet seed knockout in comparison to other schemes such as vibrational type are unclogging of seed plate hole from broken seeds and foreign matter as well as cleaning the seed metering device from dust.

During the last few years, in order to recommend suitable machines for mechanized rapeseed sowing, a national research project was conducted at the Agricultural Research Centers of East Azarbaijan, West Azarbaijan, Fars, Khouzestan and Golestan provinces in Iran. The following planters were utilized in the

project (Yousefzadeh, 2003):

1. Grain drill (with the trade name of Barzegar-Hamedan).
2. Pneumatic row-crop planter (with the trade names of Agrifarm and Noudet).
3. Mechanical row-crop planter (with the trade name of Naderi).

A review of these research reports indicated that the grain drill and the mechanical row-crop planter gave better results than the pneumatic row-crop planter. Reported seed damage figures in some experiments are unacceptably high. For example, seed damage in the Noudet Pneumatic planter, Barzegar Hamedan seeder and Naderi planter were 13.7, 6.0 and 9.6 %, respectively (Amirshagagi, 2003). However, according to previous research results, pneumatic planters caused little seed damage in comparison to mechanical planters. One of the reasons for weak performances of pneumatic planters was the absence of a suitable seed knockout mechanism. Literature review indicates that no basic study relating to seed ejection with an air-jet seed knockout device has been conducted.

A mechanical pusher or pressurized air may be needed for reliable ejection of seeds from holes (nozzles) of the seed metering device.

Reversing suction/pressure had been used successfully to pickup and eject seed from the nozzles of the seed metering device; the ejection pressure being lower than the pickup suction (Sial and Persson, 1984). An air knock-off device was used to blow the wet, light, and primed celery seed from the metering plate to the seed delivery tube in a hydro pneumatic seeder (Zulin *et al.*, 1991). To overcome sticking of the wet, light and primed celery seed and to transport the seed through the delivery tube, high-speed air was introduced into the seed delivery tube. Here, two forces help eject the seed: (1) positive knocking force of the air knock off device and (2) vacuum force due to the high speed air introduced into the seed delivery tube.

The objective of the present research was improvement of the existing plate-type vacuum planters through studying seed ejection by an air-jet seed knockout device. For this purpose, the effective parameters in seed ejection were determined theoretically. Then, an air-jet seed knockout device was designed and fabricated. Finally, the device was installed on a pneumatic row-crop planter and its effect on the planter performance was evaluated.

## Materials and Methods

### Dynamic Analysis

Important parameters in seed ejection should be identified for pneumatic design of air-jet seed knockout. Many parameters are involved in the knockout process that may be divided into three categories: those related to the seed metering plate, the knockout pawl, and the seed itself. These parameters can be arranged as the following function:

$$\Delta = f(v_e, P_e, \rho_e, T_e, S_e, v_e, d_o, d_c, \alpha, \omega_p, r_p, \mu, S_p, A_{SC}, m_s, \rho_s, g, \dots) \dots \dots \dots (1)$$

In which  $\Delta$  is seed ejection quality index.

Considering the fixed or known conditions of the metering plate holes, type of seed knockout, and environmental conditions, some of the less important factors could be eliminated. Dimensional analysis with the aid of the Buckingham Pi Theorem was used for this purpose (Fox and McDonald, 1998). Results of dimensional analysis showed that, in addition to the gravitational and centrifugal forces, minimum suction pressure was also important.

Since model development using dimensional analysis is quite complicated, dynamic analyses was used for determination of air-jet seed knockout pressure and velocity. Forces acting on a seed at the ejection

**Table 1** Notation

$A_s$	Seed area	$m^2$	$P_e$	Ejection pressure of seed knockout	Pa
$A_{SC}$	Seed cross-sectional area	$m^2$	$P_{hm}$	Minimum pressure for holding the seed	Pa
$d_s$	Diameter of seed	m	$S_p$	Coefficient of sphericity	-
$d_c$	Hole major diameter (equal to diameter of nozzle head)	m	$S_e$	Mixture length (equal to distance between nozzle of knockout and seed metering plate behind)	m
$d_o$	Hole minor diameter	m	$T_e$	Air temperature	$K^\circ$
$F_C$	Centrifugal force	N	$v_e$	Air velocity	$m\ t^{-1}$
$F_W$	Weight force	N	$\nu_e$	Air viscosity	$m^2\ t^{-1}$
$F_f$	Friction force	N	$\omega_p$	Rotational velocity of the seed plate	$rad\ s^{-1}$
$F_v$	Suction force	N	$\theta$	Angle between $F_p$ and $F_R$	degree
$F_e$	Ejection force	N	$\alpha$	Angle of seed metering	degree
$F_R$	Resistance force	N	$\mu$	Friction coefficient, between seed and nozzle	-
$g$	Acceleration due to gravity	$m\ s^{-2}$	$\rho_e$	Density of air	$kgm^{-3}$
$r_p$	Seed plate radius	m	$\rho_s$	Density of seed	$kgm^{-3}$
$r_i$	Radius of cell-loop on seed plate	m	$\Delta$	Seed ejection quality index	-
$m_s$	Weight of seed	kg			

tion and holding phase are shown in **Fig 1**. **Fig. 2** shows a seed in a seed plate hole with the acting forces. These include centrifugal force  $F_c$ , gravitational force  $F_w$ , resistance  $F_R$ , and blowing force  $F_e$ . Resistance force is the sum of seed entrapment and friction forces, as well as negligible forces such as adhesion. Seed entrapment force is caused by suction force which results in settling of the seed in one of the seed cups of the metering plate.

The relationship between forces acting on the seed at ejection is as follows:

$$F_e = (F_w + F_c) / \tan \theta \dots\dots\dots (2)$$

As shown by **Eqn. 2**, magnitude of the force required for seed ejection varies with the angle  $\theta$ . This angle that depends on seed type, rotational velocity of the seed plate, and unknown factors such as entrapment force varies between 0 and 90 degrees. Magnitude of  $F_e$  may be determined theoretically or empirically as follows.

**Theoretical Approach**

If seed cross sectional area is substituted into eqn. (2), minimum ejection pressure of air-jet seed knockout could be calculated as follows.

$$P_e = \left( \frac{F_w + F_c}{A_{sc}} \right) / \tan \theta \dots\dots\dots (3)$$

in which

$$A_{sc} = \frac{\pi}{4} (d_s \cos \alpha)^2 = A_s \cos^2 \alpha \dots\dots (4)$$

$$F_c = m r_i \omega_p^2 = \frac{F_w}{g} r_i \omega_p^2 \dots\dots\dots (5)$$

$F_c$ ,  $F_w$ , and  $A_{sc}$  are known in **Eqn. 3**. However, angle  $\theta$  is unknown. As mentioned before,  $\theta$  varies between 0 to 90 degrees. For example, canola seed and a seed plate with the following specifications:  $\alpha = 30$ ,  $r_i = 0.107 \text{ m}$ ,  $\omega_p = 8.97 \text{ rad s}^{-1}$ , and  $d_s = 1.5 \text{ mm}$  will give:

$$F_c = 3.4E^{-5} \text{ N}$$

$$F_w = 3E^{-5} \text{ N}$$

$$A_{sc} = 1.3E^{-6} \text{ m}^2$$

substitute these values into **Eqn. 3** and  $P_e$  will be:

$$P_e = 63.75 / \tan \theta$$

Knockout ejection pressure is always considerably less than the air pressure used for holding and transporting the seed. This is due to the fact that gravitational and centrifugal forces help eject the seed at ejection time. Hence,  $P_e < P_{hm}$ .

In the absence of  $P_e$ , at low velocity of seed plate, the seed would fall out due to gravity. In this case,  $\theta$  would be approximately 90 degrees. At high seed plate velocity, gravitational and centrifugal forces help eject the seed. The follow-

ing relationship is obtained based on the forces acting at suction and transport time. Using **Eqn. 6**, the minimum pressure of seed holding is 122.98 Pa (Zakidizaji, 2003).

$$\mu = 0.315$$

$$P_{hm} = \frac{4m_s r_i \omega_p^2}{\pi \mu d_s^2 \cos \alpha^2} \cos^{-1} \left( \frac{g}{r_i \omega_p^2} \right) \dots (6)$$

Hence the maximum knockout ejection pressure will be less than 120 Pa.

**Empirical Approach**

In this approach, knockout ejection pressure was measured using a simple experiment. After fabrication of an air-jet seed knockout device and its installation on the seed-metering device (**Fig. 3**), seed ejection behavior was studied by increasing air pressure from 0 to 200 Pa under different rotational velocities of the seed plate device. The optimum ejection pressure was determined by trial and error to be about 100 Pa. Seed ejection was irregular at air pressures below and above 100 Pa.

**Equipment and Materials**

The following setup was used for conducting the test. A vacuum pump (the vacuum pump of a Behkesht pneumatic planter) and a blower pump (Solo 432 motor with a nominal power of 5 HP) were used

**Fig. 1** Forces acting on the seed at ejection and suction phase

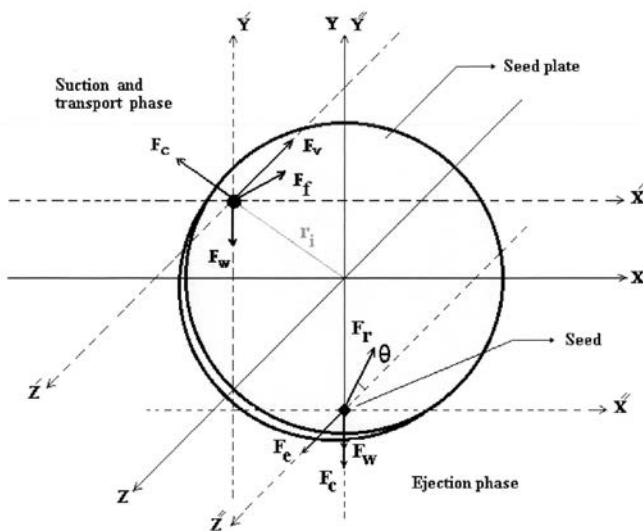

**Fig. 2** Forces acting on the seed in the seed plate hole at holding and transport phase

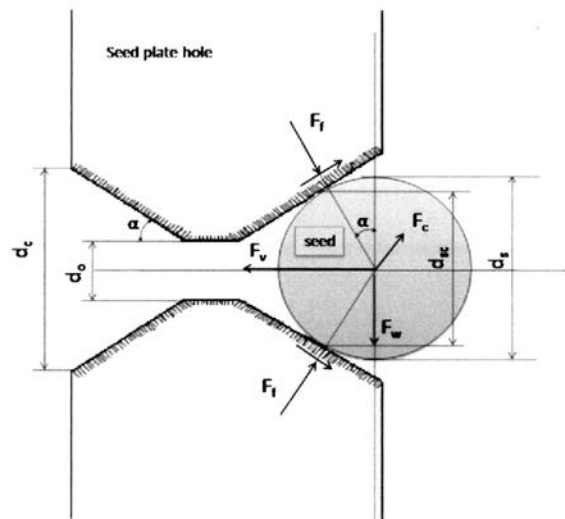

for supplying suction air of seed metering device and low-pressure air source for seed knockout device, respectively. A 1.5 HP electromotor with a LS900-4005 model inverter was used for supplying variable rotational velocity of the seed plate. The rotational velocity of the seed plate was measured using a digital tachometer. An adjustable orifice was used in the air flow line for regulating the air flow rate. Air pressure and velocity were measured using an analog manometer and digital vane anemometer, respectively. Other equipment, such as a timer and on-off controller, was provided.

A seed metering plate was used for planting canola and onion seeds. Seed plate specifications included a plate diameter of 226 mm having 1 mm diameter holes. The holes were drilled along the periphery of a 200 mm diameter pitch circle.

Canola and onion seeds that have small diameters were chosen for the test. Here, 300 g of each seed type were used for the tests. Half of each sample was cleaned manually to remove all foreign matter such as dust, dirt, stones, chaff, immature and broken seeds. The tests were conducted using two sample types, namely clean and regular samples. Characteristics of the seeds were

measured according to recommendations of FAO agricultural service (Smith, 1994). Dimensions and weight of the seeds were measured using a 0.02 mm micrometer and a 0.0001 g digital balance, respectively. Moisture content of seed was measured by following the standard method (Anonymous, 1999a). Particle density and seed viability were obtained using fluid method and a germinator, respectively.

### Test Procedure

Sufficient amount of clean and regular samples were poured into the hopper and tests were conducted. Statistical tests were conducted using only clean sample. Dependent and independent variables of the experiment are given in **Table 2**. Three levels of seed plate rotational velocity were chosen as follows: three levels of planter forward velocity (that is 1, 2, and 3 m s<sup>-1</sup>), 30 holes on the seed plate, and 17 seed per meter of distance traveled. Three levels of knockout air velocity (0, 7.5, and 15.5 m s<sup>-1</sup>) were chosen on the basis of seed terminal velocity. Air pressures at the three levels of knockout velocity were about 0, 100, and 250 Pa.

### Air-jet Seed Knockout Development

Based on specifications of the seed metering device, especially its ejection location, main segments of the air-jet seed knockout device were specified. An experimental air-jet seed knockout device was developed, consisting of a nozzle, air flow controller and air transmission tube. The seed knockout nozzle was a short and narrow copper tube with 4 mm I.D., 6.5 mm O.D., and 80 mm length. The air-jet nozzle was installed at a distance of 2 mm from the seed plate. Length and diameter of the nozzle were selected on the basis of cover thickness of the seed metering device and diameter of the seed plate holes, respectively. Due to space limitation in the seed ejection area, the nozzle was installed in a place where seeds were ejected from the vacuum portion of the seed metering device. For air transmission from the air source to the nozzle, a narrow, smooth tube was used with 1.5 m length, 6 mm ID, and 8 mm OD.

### Results and Discussion

Two types of tests were conducted in the laboratory: observation trials and statistical experiment. Observa-

**Fig. 3** Nozzle of the air-jet seed knockout device

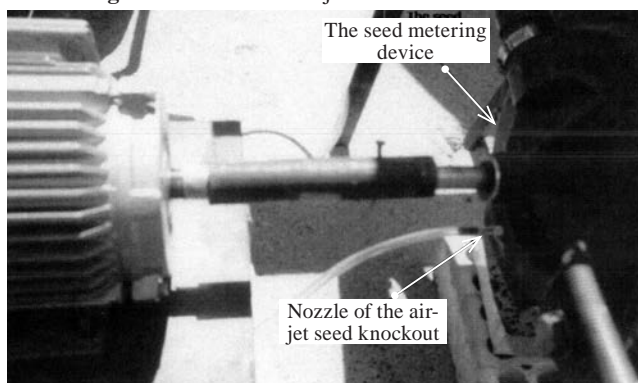

**Table 2** Independent and dependent variables of the test

Independent variables	
Rotational velocity of seed plate, rpm	1. 40 2. 68 3. 99
Air velocity of air-jet seed knockout, m s <sup>-1</sup>	1. 0 2. 7-8 (approximately 7.5) 3. 15-16 (approximately 15.5)
Seed type	Canola (okapi variety)
Dependent parameters, all in %	1. Cell filling percentage 2. Type 1 seed damage (breakage and/or splitting) 3. Type 2 seed damage (seed coat scratching and/or removal) 4. Total seed damage (sum of type one and type two) 5. Viability (%)
No. of replications	4
Total number of tests	36

tion trials included clogging check of seed plate holes and seed ejection modality. It was surmised that ejecting seed by air-jet seed knockout was the cause of seed damage because it seems that ejected seeds collide with the inner walls of the output channel. In order to check this, an experiment was arranged to study the effectiveness of air-jet seed knockout on seed damage and performance of the seed metering device.

### Observation Trials

Tests for monitoring clogging of seed plate holes were conducted using clean and regular seeds. Regular seeds included foreign materials mostly broken seeds, chaff and straw. These tests indicated that in the absence of the air-jet seed knockout device, clogging of the seed metering holes was caused by chaff, straw, and broken seeds. Clogging increased with increasing amount of foreign matter. When using air-jet seed knockout, even at low air velocities, the number of clogged holes as well as seed breakage reduced considerably. In most cases, air pressure needed for ejection of broken seeds was more than that for ejection of chaff and straw. This was due to the fact that broken seeds caused more entrapment force than chaff and straw. The amount of broken onion seeds were more than

that of canola seeds due to large variations in shape and size of the onion seeds. This phenomenon occurred in the absence of the air-jet seed knockout device.

Scattering and spreading seeds in the sowing row is one of the important problems in precision metering of small seeds. Seeds scatter on the row due to kinetic inertia force. This behavior influences spacing uniformity along the row and between seeds in neighboring rows. This phenomenon is due to the rotational velocity of the seed plate and seed weight force. Also, these tests showed that seeds eject slowly and cumulatively toward the soil surface from the outlet channel behind the seed metering device opposite the air nozzle. It is probable that this phenomenon occurred due to reducing seed impact energy by ejection force of the air-jet seed knockout device.

### Effect of Air-jet Seed Knockout on Seed Metering Performance

The first type of seed damage was produced by seed impact upon the seed cut-off plate. But the second type of seed damage, in addition to seed impact with this plate, was created by seed impacting the outlet channel of the seed metering system due to seed ejection by the air-jet seed knockout device. In this experiment, a multivariable factorial

test was utilized for determination of the effect of independent variables on the dependent parameters using Minitab and SPSS software. Results of the analysis of variance and comparison of the means for all measured parameters are shown in **Table 3**.

The analysis of variance indicated that metering plate velocity had a very significant effect on percentage of cell filling. Increasing the rotational velocity results in a significant decrease in percent cell filling, which is predictable. Increasing the air velocity somewhat increased percentage of cell filling due to clearing of the holes clogged by broken seeds. However, this increase was not statistically significant. The cell filling percentage was low because of high rotational velocity and clogged seed plate holes. Also, the first type of seed damage was 0.074 % higher than the second type. In other words, seed damage occurred mostly in the form of breakage and splitting. Air velocity had a very significant effect on mechanical damage in the form of seed splitting and breakage as well as in the form of scratching and removal of seed coat and on the sum of these values. All types of mechanical damage decreased with increasing air velocity (**Fig. 4**).

It was primarily assumed that air-jet seed knockout could result in the second type of seed damage only

**Table 3** Mean values and variance analysis of variables based on the results of MANOVA

Variables	Overall mean	A	B	A*B
Cell filling, %	70.800	0.01 0.000	NS 0.502	NS 0.870
First type of seed damage, %	0.339	NS 0.912	0.01 0.000	NS 0.970
Second type of seed damage, %	0.275	NS 0.579	0.01 0.003	NS 0.287
Overall seed damage, %	0.614	NS 0.683	0.01 0.000	NS 0.593
Seed Viability, %	93.500	NS 0.087	NS 0.324	NS 0.502

A: Rotational velocity of the seed plate, B: Air velocity of the air-jet seed knockout device. The first and second row numbers indicate the level of statistical significance and P value, respectively; NS indicates non-significance.

**Fig. 4** Effect of air velocity of air-jet seed knockout on overall seed damage

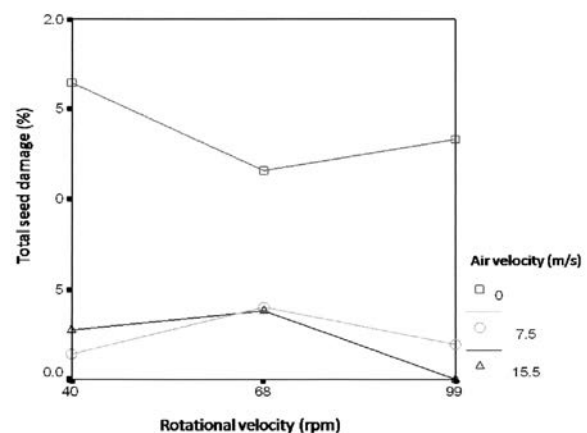

while, according to **Table 3**, the effect of air velocity on the average of the first type seed damage was less than that of the second type seed damage. But increasing air velocity caused a significant reduction in the second type of seed damage (**Fig. 5**). That is, effect of the seed knockout device on seed coat scratching and removal was low. **Fig. 4** shows that the incorporation of the air-jet seed knockout into the seed metering device reduced the total amount of seed damage.

Independent variables did not have significant effects on seed viability. However, as shown in **Fig. 6**, increasing air velocity, resulted in some increase of seed viability. It is, thus, concluded that air-jet seed knockout did not create any seed damage leading to reduction of viability.

## Conclusions

An air-jet seed knockout device was designed, developed, and tested. Seed ejection was then experimentally studied using this device. Minimum pressure for holding the seed and the ejection pressure of the air-jet seed knockout was about 123 and 100 Pa, respectively, for canola seed. Broken seeds caused clogging the seed plate holes more than

chaff and straw. Consequently, the required air velocity to eject broken seeds was more than that for chaff and straw. Using air-jet seed knockout, the number of clogged holes of the seed metering device and broken seeds reduced significantly. Without the air-jet seed knockout device, seed scattering occurred at ejection, while the air-jet seed knockout device decreased this effect and resulted in a more uniform ejection pattern. Not only did the air-jet seed knockout device decrease seed damage but, due to clearing the seed metering plate cells clogged by broken seeds and plant debris, it increased the cell filling percentage and improved overall performance of the seed metering system.

## REFERENCES

- Amirshagagi, F. 2003. Investigation and evaluation of common small seed planters and introduction of the best one for mechanized rape-seed sowing. First student conference on agricultural machinery engineering. Urmia, Iran.
- Anonymous. 1999a. Moisture measurement - ungrounded grain and seeds (pp. 551-552). ASAE Standard S 352-2. American Society of Agricultural Engineers. St. Joseph, MI.
- Fox, W. R. and A. T. McDonald. 1998. Introduction to Fluid Mechanics. 5th edition. John Wiley & sons, Inc. USA. 781p.
- Sial, F. S. and S. P. E. Persson. 1984. Vacuum nozzle design for seed metering. Transactions of the ASAE. 3(4): 688-696.
- Smith, D. W., B. G. Sims, and D. H. O'Neill. 1994. Testing and Evaluation of Agricultural Machinery and Equipment, Principles and Practices. FAO Agricultural Services Bulletin 110. Produced by the Overseas Division of the Silsoe Research Institute, U.K. 274p.
- Yousefzadeh Taheri, M. R. 2003. Evaluation of ordinary small seed planters and their suitable recommendation for mechanized rape-seed sowing. Research report. East Azerbaijan Research Center for Agriculture & Natural Resources.
- Zakidizaji, H. 2003. Pneumatic Design of a Double-Purpose Planter for Planting of Small Seeds and Development and Testing of its Knockout Pawl. Unpublished M.S. thesis. Dep. of Agricultural Machinery Engineering. Tarbiat Modarres University.
- Zulin, Z. S. K. Upadhyaya, S. Shafii, and R. E. Garrett. 1991. A hydropneumatic seeder for primed seed. Transactions of the ASAE. 34(1): 21-26.

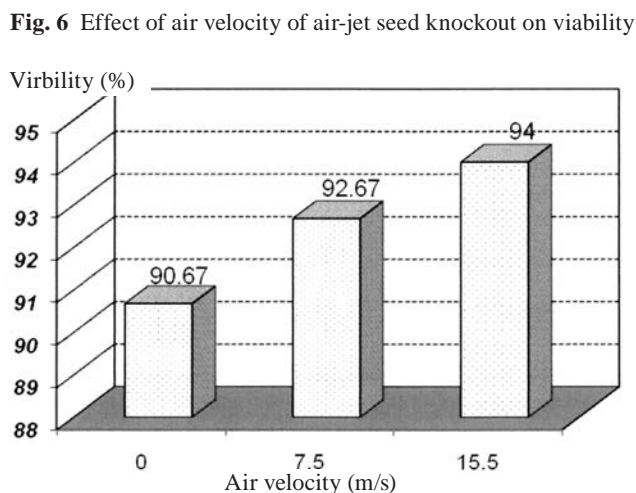
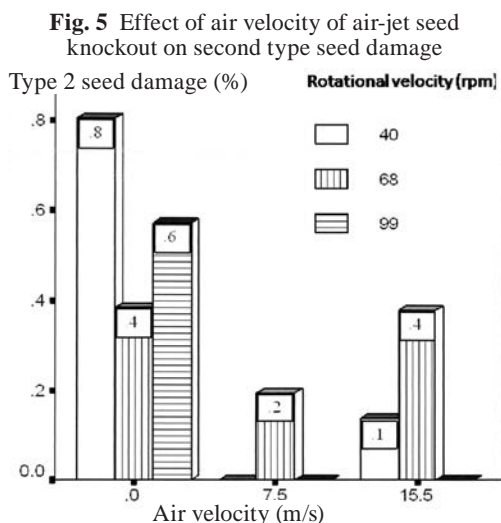



# Sowing Methods with Different Seed Drills for Mechanizing Mountain Farming

by  
D. K. Vatsa  
Agricultural Engineer  
Department of Agricultural Engineering  
CSKHPKV, Palampur-176062.  
INDIA  
erdkvatsa@hotmail.com

Sukhbir Singh  
Assistant Agricultural Engineer  
Department of Agricultural Engineering  
CSKHPKV, Palampur-176062  
INDIA  
srsukhbir@rediffmail.com

## Abstract

Most of the farmers in the mountains use traditional methods for planting such as broadcasting and seed dropping behind the plough due to undulating topography, small plots and higher cost of equipment. This also affects germination due to non-uniform placement of seeds at proper depth. A study was conducted on various available seed drills/planters and they were compared with traditional methods for mechanizing wheat crop sowing and for enhancing the productivity. The effective field capacities were 0.039, 0.036, 0.12, 0.035 and 0.024 ha/h with field efficiency of 65, 63, 69, 65 and 57 % with manual seed drill, manual multi-crop planter, power tiller multi-crop planter, dropping seed behind hand plough and sowing behind animal plough, respectively. The labour requirement was higher for the hand plough and sowing behind the plough than for the seed drills. The cost of operation was 2-4 times lower for the seed drills. The yield was about 15-18 % higher with seed drills and planters and significantly higher compared to traditional method. The body discomfort rating for 17 body parts were collected in which six body parts were found

to experience serious discomfort in the following order: left shoulder, right shoulder, left arm, right arm, left leg and right leg in case of hand plough, seed drill and planter pulled by the subject. It was concluded that power operated and animal operated equipment were better than manual operated for sowing wheat crop.

## Introduction

Wheat is the main crop in the mountain region of Rabi season and sown in an area of about 376 thousand hectare out of total cultivated area of 558 thousand hectare. Generally, this prominent field crop is sown by using traditional methods that are broadcasting and seed dropping behind a plough, which affects germination due to non-uniform placement of seeds at proper depth. In this system, the farmers apply more than 40 % seed rate above that recommended to ensure optimum plant population because some of the seeds are eaten by the birds at the time of sowing. The placement of seed at proper depth is the most important factor in sowing and contributes significantly in production, particularly in rainfed conditions. Besides, the interculture operation with improved weeders is not pos-

sible in the broadcasting method.

Topography and size of land holding are the other two major constraints that restrict the introduction of power equipment and modern agricultural implements like the tractor in these areas. Presently, hill farmers are using mainly bullocks for ploughing but high cost of rearing has forced the farmers to adopt a mechanical power source that suits hill agriculture. In addition, the turning of bullocks with implements is a great problem in small terraces. At the present time, a number of improved seed drills and multi-crop planters (Ahmed, *et al.*, 1994; Singh and Singh, 1995; Unadi and Gupta, 1994) have been developed and evaluated in the plain areas. The hilly state, which is unique in topographical features needs totally different equipment with a small power source. In order to eliminate the negative side effect of the traditional method of sowing, the various sowing equipment was evaluated with respect to the traditional system in wheat.

## Methodology

The conventional and modern equipment available for sowing in the country were evaluated, by

taking the main parameters such as capacity, efficiency, labour requirement and cost of operation, by standard techniques using the BIS test code, as shown in Fig. 1. The other parameters such as soil moisture, bulk density, mean clod weight and diameter and draft were also recorded in various farm operations wherever needed. The draft was measured with a spring dynamometer having 100 kg capacity with a variation of  $\pm 500$  g. The experiment was conducted in a 3.5 m  $\times$  8.0 m plot with a randomized block

design. It included a manual seed drill (S<sub>1</sub>), manual multi-crop planter (S<sub>2</sub>), power tiller multi-crop planter (S<sub>3</sub>), hand plough (S<sub>4</sub>), sowing behind animal drawn plough (S<sub>5</sub>) and animal drawn CIAE seed drill (S<sub>6</sub>). The major specifications of the sowing machines are shown in Table 1.

To assess fatigue, the ergonomic parameters were determined by subjective assessment and the postural discomfort experienced by the subject while operating the implements. Overall body discomfort was calculated using the modified

5 point scale of Corlett & Bishop (1976) (1. No discomfort, 2. very little discomfort, 3. mild discomfort, 4. great discomfort, 5. extreme discomfort). The body area discomfort rankings (Wilson and Corlett, 1990) were also used as illustrated in Fig. 2. The overall discomfort, tiredness and localized body area discomfort were noted every half-hour of working. To avoid ambiguity, subjects were asked to indicate the body area that was most painful followed by next most painful area, till no further area was left. In this method of ranking, each item was marked numerically and then the marks were added for each body part and each subject. Three subjects (S<sub>1</sub>, S<sub>2</sub>, S<sub>3</sub>) were selected in an age group ranges from 35-40 years for the study. Before starting the experiment, the subjects were given a briefing about the experiment to be conducted. The subjects were also not allowed to eat or smoke during the experiment. The subjects were engaged for 2 hours continuous work. In the experiment, after 30 minutes of effective working, 10 minutes rest was given to each subject.

Fig. 1 Sowing equipment used for the study

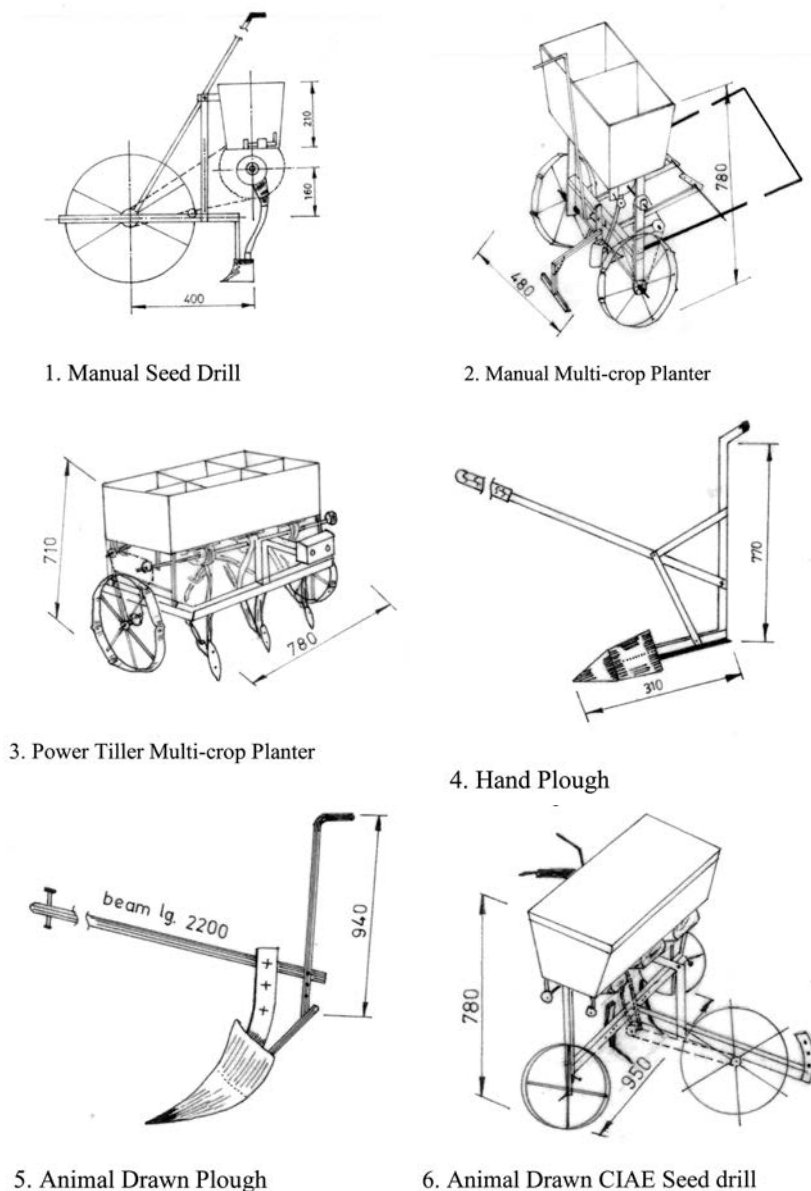
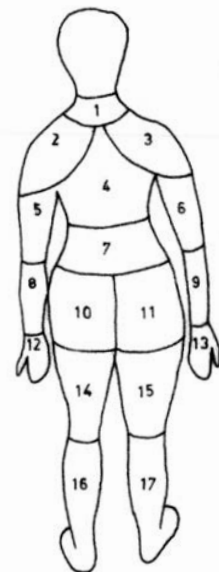

Fig. 2 Example of body map for discomfort assessment



## Results and Discussion

The comparative performance of various sowing methods in wheat crop is given in **Table 2**. The seed drills and sowing methods used in the study are shown in **Fig. 1**. It is evident from the table that the actual seed rate adjusted was more or less the same with all the seed drills but the seed rate with the hand plough was greater as per farmer practice. The effective field capacities were 0.039, 0.036, 0.120, 0.035 and 0.024 ha/h with field efficiency of 65.2, 63.3, 69.1, 65.1 and 57.4 % with S<sub>1</sub>, S<sub>2</sub>, S<sub>3</sub>, S<sub>4</sub> and S<sub>5</sub>, respectively. The

field efficiency was less due to small plots. However, the animal drawn seed drill could not be operated in a small field due to the turning problem.

The labour requirement was higher for the hand plough and sowing behind the plough than that of seed drills and the placement of seed was also not uniform. This was due to additional labour required for placing the seed and fertilizer. The cost of operation with the power tiller multi-crop planter was lower by 2-3 times compared to seed dropping behind hand plough. The yield was about 15 % higher with both

multi-crop planters compared to traditional sowing. The yield was also significantly higher for both multi-crop planters. Operation of both the planters is shown in **Figs. 3** and **4**. The small and marginal farmers could afford the cost of the implements, particularly the manual drawn for their farm since the cost is well within their reach.

**Fig. 5** shows overall discomfort score and area covered with different sowing equipment. The discomfort score increases as the time increases with all the equipments. It is also clear from the **Fig. 5** that the discomfort score was higher for the multi-crop planter because it needs higher labour for operation due to the heavy weight in comparison with the other equipment used in the study. However, area covered was more or less the same for S<sub>1</sub>, S<sub>2</sub> and S<sub>4</sub> but it decreased as the time increased. That is, after 30, 60, 90 and 120 minutes of working.

The body part discomfort score was also collected using body diagrams with each sowing equipment to enable the different body parts to be ranked in order of discomfort

**Table 1** Major specifications of various sowing machines

Parameters	Type of sowing machines					
	S <sub>1</sub>	S <sub>2</sub>	S <sub>3</sub>	S <sub>4</sub>	S <sub>5</sub>	S <sub>6</sub>
<b>Overall dimensions, mm</b>						
Length	790	1,570	690	1,420	2,300	850
Width	460	530	710	120	200	1,010
Height	1,100	900	700	950	1,200	800
Weight, kg	11	18	35	2.5	13	45
Developed at	Falcon	HPKV	HPKV	Local	Local	CIAE
Furrow opener	Shovel	Shovel	Shovel	Shoe	Shoe	Shoe
Seed metering	Fluted	Vertical roller with cells	Vertical roller with cells	-	-	Fluted
Fertilizer metering	-	Fluted	Fluted	-	-	Fluted
Suitability of crops	Wheat	Wheat, maize, soybean	Wheat, maize, soybean	-	-	Wheat

**Table 2** Comparative performance of the sowing methods in wheat crop  
Average soil moisture content = 14.5 %, Bulk density = 1.32 g/cc

Parameter	Average value of sowing method				
	S <sub>1</sub>	S <sub>2</sub>	S <sub>3</sub>	S <sub>4</sub>	S <sub>5</sub>
Speed of operation, km/h	2.10	2.05	2.15	2.20	2.30
Actual seed rate, kg/ha	123.5	124.1	123.0	150.4	130.2
Actual fertilizer rate, kg/ha	278.0	275.1	276.5	278.0	278.0
Depth of sowing, mm	49	52	49	38	56
Effective field capacity, ha/h	0.038	0.035	0.10.0	0.034	0.023
Field efficiency, %	64.5	63.2	67.9	65.1	55.7
Labour requirement, man-h/ha	80	86	20	147	130
Fuel consumption, l/h	-	-	0.96	-	-
Cost of operation, Rs/ha	585	630	558	890	1,910
Cost of implement, Rs*	1,000	1,500	7,500	200	300
Yield, t/ha	3.23	3.52	3.75	3.02	3.15
CD at 5%	0.42				

\*one \$ = Rs.40

**Fig. 3** Manual multi-crop planter in operation



**Fig. 4** Power tiller multi-crop planter in operation



experienced. Out of all the subjects rating of 17 body parts, six body parts experienced serious discomfort. In order of discomfort, they were left shoulder, right shoulder, left arm, right arm, left leg and right leg for hand plough, seed drill and multi-crop planter pulled by the subjects. Most of the subjects complained of high draft. Due to more fatigue, it was suggested that power operated equipment was better than the manual operated method for sowing the wheat crop. Thus, there is need to develop a two row animal drawn seed drill that is suited to hill terrain for reducing drudgery.

## Conclusions

The following conclusions could be drawn from the study:

1. The effective field capacities were 0.039, 0.036, 0.120, 0.035 and 0.024 ha/h with field efficiency of 65.2, 63.3, 69.1, 65.1 and 57.4 with manual seed drill, manual multi-crop planter, power tiller multi-crop planter, dropping seed behind hand plough and sowing behind animal plough, respectively.
2. The labour requirement was higher for hand plough and sowing behind plough than that of seed drills.
3. The cost of operation was 2-4

times lower by using seed drills and planters.

4. The yield of wheat was significantly higher with seed drills and planters compared to the traditional method.
5. Due to more fatigue, it was suggested that power operated equipment was better than manual operated method for sowing wheat crop.

## REFERENCES

- Ahmed, M., M. A. Zaidi, and A. S. Khan. 1994. Development and adoption of no till technology for sowing wheat. *AMA*. 25(4): 24-28.
- Anonymous. 1971. Test code of seed-cum-fertilizer drill. IS: 6361-1971. Bureau of Indian Standards, New Delhi.
- Anonymous. 1979. Guide for estimating cost of farm Machinery operation. I.S. 9164-1979. Bureau of Indian Standards, New Delhi.
- Anonymous. 2000. Package of practices for Rabi and Kharif crops. Directorate of Extension Education, HPKV, Palampur.
- Anonymous. 2003. Statistical Outline of Himachal Pradesh. Dept. of Economics and Statistics Government of Himachal Pradesh, Shimla.
- Corlett, E. N. and R. P. Bishop. 1976. A technique for assessing postural discomfort. *Ergonomics*. Vol. 19 No.2. 175-182.
- Singh, B. and T. P. Singh. 1995. Development, performance and evaluation of zero till fertilizer seed drill. *J. Agric. Engg.* 32(1-4): 13-23.
- Unadi, A. and C. P. Gupta. 1994. Development of two wheel tractor operated seed-cum-fertilizer drill. *AMA*. 25(1): 25-28.
- Wilson, J. R. and E. N. Corlett. 1990. Evaluation of human work: A practical ergonomics methodology. Tayler and Francis, London.

Fig. 5 Overall discomfort score and area covered with different sowing implements

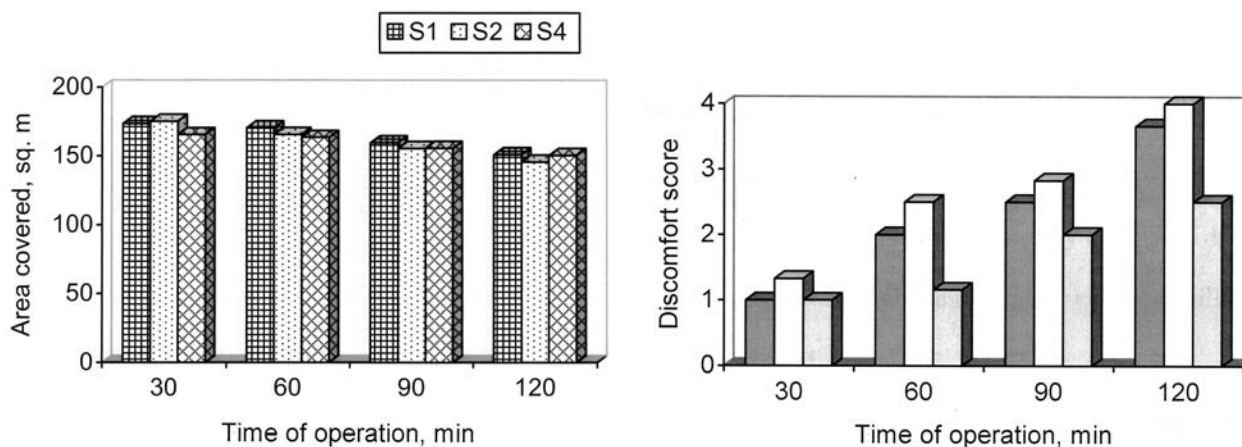

# Performance of Sweet Potato Transplanting Machine on Mineral and Bris Soils

by  
Akhir Hamid  
Mechanization and Automation Center,  
MARDI, P. O. Box 12301,  
50774 Kuala Lumpur  
MALAYSIA

Desa Ahmad  
Department of Biological and  
Agricultural Engineering,  
Faculty of Engineering,  
UPM Serdang  
MALAYSIA

Ibni Hajar Rukunuddin  
Mechanization and Automation Center,  
MARDI, P. O. Box 12301,  
50774 Kuala Lumpur  
MALAYSIA

## Abstract

Sweet potato cultivation is labour-intensive and needs mechanization to reduce labour and drudgery of the farmer in the planting operation. In this study, an imported double-row planter developed for vegetable planting was modified and tested on mineral and bris soils. Preliminary results gave a field capacity of one hectare per eight hour day for mineral soil and 0.5 hectare for bris soil. Manual planting required 150 man-days per hectare. Based on the field tests, the modified planter performed satisfactorily as a sweet potato transplanting machine as it helped reduce the cost of operation, labour requirements and increase timeliness. However, its performance was adversely affected by soil moisture, which should be less than 21 % (dry basis) for mineral soil and more than 18 % (dry basis) for bris soil. The work rate on mineral soil was 0.12 ha/hr while on bris soil the work rate was 0.098

ha/hr. The planting cost using the machine was estimated to be RM 232.45/ha while the manual planting cost was about RM 960.00/ha. The modified transplanter without a fertilizer hopper cost about RM 14,000.

## Introduction

A number of sweet potato varieties have been studied and developed in Malaysia. The latest two varieties were released in Kelantan and named Jalomas and Telong (Tan *et al.*, 2000). Both of these varieties had their own special features and advantages. The traditional planting technique for these varieties was still by manual method due to small trial plots. The new varieties had the potential to be processed commercially into flour due to their high starch content (Tan *et al.*, 2000). Because of the potential demand of sweet potato flour in the food products industry, field production needed to be increased. Hence, ma-

chines for field operations needed to be identified or developed to plant sweet potatoes on a larger scale for the flour industry.

A number of planting machines have been developed in several parts of the world. Mat Daham (1990) evaluated a single row transplanter for planting tobacco seedlings and also studied tobacco cultivation using a two-wheel pedestrian tractor and a single-row transplanter. A modified imported semi-mechanical one-row-planter for cassava cuttings was tested on mineral soil (Sukra *et al.*, 1990 and Sukra *et al.*, 1992). The planter performed satisfactorily and saved about 67 to 78 % in labour requirement compared to the manual method.

Malaysia is among the lowest sweet potato producing countries in Asia and the world (Tunku

## Acknowledgments

The authors wish to thank Mr. Aris Abdullah and Mr. Salleh Barados for assistance during field trials.

Mahmud, 1999). With the presence of unused land, there is a possibility of exporting sweet potatoes from Malaysia since almost all of the agricultural and ex-mining areas in the Malaysia Peninsular are suitable for sweet potato production, either as a rotational crop or an intercrop with other industrial crops such as rubber, oil palm and coconut (Suboh, 1999).

Tobacco cultivation would no longer be competitive after AFTA was implemented in 2003 (Tengku 1999). In order to replace the established tobacco industry, Malaysia needed to find another industry which would bring in the same returns as the existing tobacco industry. Sweet potato was one of the alternative crops for tobacco (Tan, 2000). This industry should be established with mechanization to overcome labour shortage. Currently planting of sweet potato per hectare manually (40,000 cuttings) would require 155 man-hours or 10 man-days.

## Materials and Methods

### Description of Machine

An imported vegetable double-row type of planter was used in this experiment. The planting machine was tested, using a 60 HP tractor. The machine had a 10-plant clip holder attached to a chain which is sprocket-driven. Spacing between rows was set at an optimum of 50 cm, and the plant holder gearing sprocket was set at 12:22 whereby

the machine can provide a spacing of 30-40 cm between plants within a row. Each unit of the double-row planter was operated by two persons. Both operators need to feed the sweet potato cuttings into the plant clip holder. The top end of the cutting was held up by a rubber gripper while a rubber extension supported the "root" end. The driver had to control the tractor speed to give sufficient time for the operator to feed the cutting into the planter fingers.

### Soil Characteristics in Experimental Plot

Normally, bris soil contained more than 95 % sand and 5 % loam and clay. The nutrient content was lower and needed to be improved by adding an organic fertilizer (Aminuddin *et al.*, 1985 and Yeoh, 1986). It had a low value for cohesion with a high frictional coefficient due to the

granular nature of the particles. It also had high internal friction while the shear stress was lower and the potential for tractor tire slip was higher during drag force operation. For mineral soil plots, the soil structure normally was made up of 30 % sand, 60 % clay and 10 % loam and organic matter. This type of soil had a good cohesion value.

### Experimental Data Collection

The major parameters considered in this study included:

- Time required for the planting operation
- Comparative spacing between plants by gear setting
- Fuel consumption of the 60 hp tractor during operation
- Estimated operation cost by machines
- Accuracy of planting

Two different locations were prepared for machine testing. The first

Fig. 1 Sweet Potato Transplanting Machine

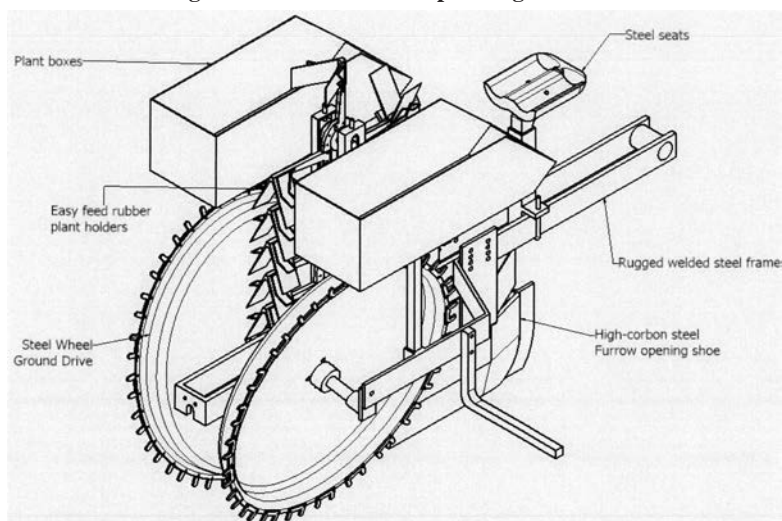

Fig. 2 Duoble row transplanter



Fig. 3 Two month after planting



Fig. 4 Single row transplanter



location was on mineral soil at the MARDI Station, Serdang, Selangor, while the second location was on bris soil at the MARDI Station, Telong, Kelantan. At each location, 12 seedbeds were prepared. Each seedbed had a width of 1.5 meters, while the length of the seedbed varied depending on the plot size. The length

of the seedbed at Serdang was 65 meters and at Telong was 50 meters. The time of operation was measured with stopwatches and the fuel consumption was measured with a fixed data logger setting on the tractor. The time to cover the bed distance as well as the turning time for each operation was recorded. The tractor

was driven in low gear (gear two) with an average engine running speed of 1,490 rpm. Sweet potato cuttings of approximately 30 cm length were used in the study.

## Results and Discussion

The test results of the vegetable planter machine are presented in **Tables 1** and **2**. The actual planting distance varied from 37 to 44 cm against the set planting spacing of 30 cm. Based on the field operations, the deviations were affected by the soil conditions. The mineral soil had a structure similar to sandy clay soil while bris soil had more than 90 % sand. The slippage of traction force on bris soil was higher than mineral soil. To reduce the tires slippage on bris soil, the speed of the tractor had to be considered. **Table 3** shows that the speed of the tractor on mineral soil was higher than the speed on bris soil. However, the field efficiency on bris soil was still lower than the mineral soil. This was due to inexperienced operators feeding the cuttings into the plant holder clips. The operators feeding the cuttings were not synchronized with the tractor speed. Misfeeding and missed planting points occurred within the row of the bed.

The soil structure and properties will determine the machine mobility. For mineral soil, the bearing capacity of the tractor track was higher compared with bris soil (Mat Daham, 1990). The planting index, which is defined as the ratio between the average plant spacing and the setting value of 30 cm was also affected for the above reason.

The field efficiency, which is the ratio between the actual field capacity and the theoretical capacity, was affected by soil structure and the inexperience in operating the machine to synchronize with the tractor speed as shown in **Tables 1** and **2**. The mean planting index was 1.25 on bris soil while the average field

**Table 1** Field evaluation results on mineral soil

Row No.	Length of run, m	Time to plant, s	Turning time, s	Plant spacing, m	Planting index	Field efficiency, %
1	87.3	285	68	0.42	1.06	81
2	98.5	160	50	0.42	1.07	81
3	93.2	240	58	0.40	0.9	81
4	83.7	230	45	0.42	1.07	84
5	78.4	223	47	0.41	1.05	83
6	79.3	206	48	0.43	1.10	81
7	97.1	200	48	0.40	1.04	81
8	88.3	195	33	0.40	1.02	90
9	76.9	187	53	0.42	1.07	80
10	87.6	152	53	0.44	1.12	74
11	87.1	185	58	0.40	1.02	80
12	77.6	181	45	0.42	1.05	80
Total	1035	2444	561	4.98	12.57	976
Mean	86.25	203.67	51	0.415	1.0475	81.33

**Table 2** Field evaluation results for bris soil

Row No.	Length of run, m	Time to plant, s	Turning time, s	Plant spacing, m	Planting index	Field efficiency, %
1	50	231	62	0.39	1.26	78.8
2	50	283	60	0.37	1.19	82.5
3	50	194	62	0.38	1.22	75.8
4	50	220	60	0.38	1.22	78.6
5	50	232	62	0.38	1.22	78.9
6	50	222	60	0.39	1.30	78.7
7	50	228	60	0.38	1.22	79.2
8	50	190	61	0.38	1.22	75.7
9	50	220	62	0.39	1.30	78.0
10	50	220	62	0.37	1.19	78.0
11	50	226	65	0.39	1.30	77.7
12	50	284	60	0.41	1.32	82.6
Total	600	2750	736	4.61	14.96	944.5
Mean	50	229.17	61.33	0.38	1.247	78.708

**Table 3** Summary of test results

Soil type	Field capacity, ha/h	Fuel consumption, L/ha	Field efficiency, %	Planting index	Plant spacing, m	Tractor speed, m/sec
Mineral	0.120	98	81.33	1.05	0.42	0.42
Bris	0.093	136	78.71	1.25	0.38	0.22

efficiency was 78.71 %. For mineral soil, the mean planting index was 1.05 and the average field efficiency was 81.33 %. This showed that for any planting machine, bris soil caused the tractor tires and machine track to slip. For mineral soil the field efficiency was a little higher due to lower incidence of slipped tracks during operations. The size of the tractor also caused the tractor tires to be buried in the sand, creating high resistance to the tractor engine power. Sometimes the tires slipped in the sand and increased the time of planting. Fuel consumption for each operation was recorded directly by the computer on the tractor. The fuel consumption on mineral soil was, on average, 98 liters per hectare, and 136 liters per hectare on bris soil. The fuel consumption also depended on soil moisture

conditions. The soil moisture for mineral soil was between 18 to 20 % (dry basis). Based on observation, if soil moisture was more than 21 %, the machine would not be moving smoothly due to soil blockage on the press wheel. For bris soil, the machine could work smoothly in any soil conditions even in flooded areas. However, sweet potatoes will be damaged under flooded condition.

### Operation Cost

The operating time and cost for mechanized sweet potato production are shown in **Table 4**. Planting by machine will reduce the time of planting and labour cost. **Table 5** shows the comparison on production costs between manual and machine in three types of soil. The total cost of operation using machines was

about RM2252.68. The estimated operational costs for sweet potato production on three types of soil by manual operation was reported by Tan (2000). By comparison, the production cost with machines was about RM0.14/kg, while the manual production cost was estimated to be about RM0.19/kg. On bris soil, the manual operating cost was RM0.27/kg. The cost was expected to vary from year to year depending on material cost and labour charge.

### Conclusions

The vegetable double-row planting machine was tested and gave promising results. With better operator training, it had great potential for planting sweet potato cuttings in a large area without high labour re-

**Table 4** Operating cost for mechanized production of Sweet potato on mineral soil

Operation	material	material	Fuel machine	Fuel machine	Labor	Labor	Total
	Unit/ha	Cost/ha	L/ha	Cost/ha	Hr/ha	Cost/ha	RM/ha
<b>Field Operation</b>							
Tillage							
Plough			18	11.70	3.0	18.75	30.45
Harrow			18	11.70	3.0	18.75	30.45
Rotor ridging (bed formation)			24	15.60	4.0	25.00	40.60
Weed control (Pre-emergence, L/ha)	4.5	90.00	18	11.70	3.0	18.75	120.45
Planting (RM 0.02/cuttings)	40,000.0	800.00	98	63.70	15.0	168.75	1,032.45
Maintenance							
Chicken dung, (t/ha)	2.5	300.00	15	9.75	2.5	15.62	325.37
NPK fertilizer		185.00	15	9.75	2.5	15.62	210.37
Interrow weeding and NPK application			15	9.75	2.5	15.62	25.37
Endosulfan granules (16kg)		50.00					50.00
Malation (RM15/L) + Benomyl (RM35, 0.5kg)		50.00	15	9.75	2.5	15.62	75.37
Irrigation			50	32.50	3.0	100.00	132.50
<b>Harvesting</b>							
Slashing			12	7.80	2.0	12.50	20.30
Digging & Collection (container & bag)			98	63.70	12.0	75.00	138.70
Field Handling (Tractor & trailer)			12	7.80	2.0	12.50	20.30
Total		1,475.00	374	265.20	57.0	512.48	2252.68

Machines operator paid RM 6.25/hour work



quirement. This machine could plant sweet potato cuttings in one hectare on mineral soil in 6-8 hours and on one hectare of bris soil in about 12.5 hours. This means that planting sweet potato by machine on mineral soil was faster than on bris soil.

The production cost by using the machines was estimated at RM0.14/kg compared to manual operation production costs of about RM0.19/kg in mineral soil and RM0.27/kg on bris soil. For manual operations, at least 10 days were required to

complete planting on a hectare with 40,000 sweet potato cuttings. The normal operational costs for planting on a contract basis were about RM960.00 (cost of contract planting was about RM24.00/1,000 cuttings) while operational cost for planting by machine was about RM168.75 per hectare. Based on this estimation, more than 80 % of the planting operational cost could be reduced.

**Table 5** Estimated costs (RM) for producing 1 ha of sweet potato on mineral soils, bris soils and drained peat by manual means and on mineral soils by machines (Tan *et al.*, 2000)

Cost item	Manual production			Mechanical production mineral soils
	Mineral soils	Bris soils	Drained peat	
<b>Land preparation (contract)</b>				
2 rounds tillage	400			400
1 round tillage		200	200	
1 round ridging	200	200	200	200
<b>Planting</b>				
Planting materials§	800	800	800	800
Labor* for planting	240	240	240	120**
<b>Fertilizer application</b>				
5 t dolomite lime			400	
Labor for lime application			75	
2.5 t chicken dung	300			300
10 t chicken dung		1200		
Labor for chicken dung application	75	150		45**
Chemical fertilizers				
34 N, 34 P <sub>2</sub> O <sub>5</sub> , 67 K <sub>2</sub> O	185		185	185
17 kg CuSO <sub>4</sub> .5H <sub>2</sub> O			55	
Labor for application	75		75	30**
80 N, 60 P <sub>2</sub> O <sub>5</sub> , 120 K <sub>2</sub> O		735		
Labor for 3 applications		225		
Weed control				
4.2 L alachlor	90	90	90	90
Labor for spraying	150	150	150	30**
Pest control				
16 kg endosulfan granules	50	50	50	50
Labor for application	150	150	150	45**
1 L malathion	15	15	15	15
0.5 kg benomyl	35	35	35	35
Labor for spraying	150	150	150	45**
<b>Irrigation</b>				
At plant establishment	180	180	180	180
Additional		180		
<b>Harvesting</b>				
<b>Yield of 20 t @ RM33/t</b>	<b>660</b>	<b>660</b>	<b>660</b>	<b>150**</b>
Total costs	3,755	5,410	3,710	2,720
Cost per kg roots (RM)	0.19	0.27	0.186	0.136

§ Non-recurrent cost after 1st crop of sweet potato

\* Labor cost : RM15 per man-day

\*\* Machine operator paid RM15 per hour

## REFERENCES

- Mat Daham, M. D. 1990. Penge-luaran tembakau dengan meng-gunakan traktor duaroda. Teknol. Kejuruteraan Pertanian, Jil.1.
- Sukra, A. B., S. L. Tan, S. K. Chan, H. dan Noor Auni. 1992 Pengelu-aran ubi kayu secara berjentera di tanah mineral. MARDI report.
- Sukra, A. B., T. I. Tengku Ahmad, and S. L. Tan, 1990. Modified API cassava planter performance, owning and operating costs. MARDI Report No. 144.
- Suboh, I. 1999. Use of immature oil palm plantations for intercropping with root Crops. Paper presented at a workshop on National R&D priority setting on root Crops. Mines Beach Resort, Seri Kem-bangan, Selangor 14-15 Sept..
- Tan, S. L., K. C. Mooi, A. Zaharah, A. M. Abd. Aziz, I. Khatijah, L. Cheah, and H. H. Tan. 2000. Two new sweet potato varieties for processing into food Products. Poster presented at the MARDI Senior Staff Conference 2000. 19-20 September 2000, Genting Highlands.
- Tunku Mahmud, T. Y. 1999. The status of root crop production in Malaysia and market potential. Paper presented at a workshop on National R&D priority setting on root crops, Mines Beach Resort, Seri Kembangan, Selangor, 14-15 Sept..

■ ■

# Optimization of Machine Parameters of Finger Millet Thresher-Cum-Pearler



by  
K. P. Singh  
Research Scholar  
Agriculture and Food Engineering Department,  
Indian Institute of Technology  
Kharagpur-721 302,  
West Bengal,  
INDIA



Supradip Saha  
Scientist  
Vivekananda Institute of Hill Agriculture  
Indian Council of Agricultural Research  
Almora-263 601 (UA),  
INDIA



H. N. Mishra  
Professor  
Agriculture and Food Engineering Department,  
Indian Institute of Technology  
Kharagpur-721 302,  
West Bengal,  
INDIA

## Abstract

Finger millet (*Eleusine coracana*) is an important staple food grain in North Western Himalayan Region (NWHR) of India. In the traditional process, it takes five hours effort for threshing and pearling of 100 kg of finger millet grain. The objective of the present study was to find the optimum machine parameters for efficient threshing and pearling operations of finger millet using artificial neural network (ANN) and genetic algorithm (GA) techniques. The machine performances like threshing capacity (32.4 kg/h against 33.21 kg/h predicted), threshing efficiency (98.41 % against 97.90 % predicted), pearling capacity (65.0 kg/h against 65.12 kg/h predicted) and pearling efficiency (98.3 % against 98.60 % predicted) were evaluated for its optimal design parameters, viz., number of canvas strips on the drum periphery (8), overhanging width of canvas strips (5.17 mm) and peripheral drum speed (7.97 m/s) for finger

millet.

## Introduction

Minor millets are important food crops for a large section of people in rural, tribal and hilly areas (Rai, 2000). These crops are mainly grown in harsh environments (rain-fed and temperature more than 20 °C) where the yield of other crops are very poor and are less prone to disease and pests. Recent developments show that the millet forms very good raw material for manufacturing of health foods. The epidemiological evidences indicate that persons on millet based diets have good resistance to degenerative diseases such as heart disease, diabetes and hypertension (Anon, 2001). Apart from health benefits, millet is also a good source of energy, protein, vitamins and minerals (Rao, 1986). The proteins are a good source of essential amino acids except lysine and threonine

but are relatively high in methionine (Gopalan *et al.*, 1997). They are a rich source of phytochemical and micronutrients and, hence, are rightly termed as “nutria-cereals” (Sehgal and Kawatra 2003). Some millet is even better in protein, oil and mineral content but use in the diet is limited because of processing difficulty, characteristic flavour, and lack of gluten and grittiness (Malleshi, 1986). Finger millet is a rich source of calcium and dietary fiber, and is known for its health benefits (Barbeau & Hilu, 1993; Malleshi, 2005). The utilization of millet for food is mostly confined to traditional consumers and population of lower socio economic strata (Maleshi and Desikhachar, 1985). The major reason for this is prob-

## Acknowledgement

The first author is grateful to Indian Council of Agricultural Research (ICAR), New Delhi for the financial assistance received to carry out the work.

ably the lack of appropriate post harvest technologies for management of these crops. Development of suitable processing methods for small millets and nutritious food products is essential to the promotion of utilization of these millets in India where nearly 63 percent of children under five years of age are malnourished (Rhode, 1994).

In India, finger millet is a major staple in the State of Uttarakhand, Chhattishgarh and Karnataka where

it is grown widely with yield as high as 3 t/ha. The major share of consumed finger millet grain is processed at the household level. The indigenous threshing of finger millet is done either by sticks or by treading out the crop panicle under the feet of oxen. The pearling operation is generally done by manual pounding (Fig. 1). These two operations are most time consuming, laborious and uneconomical for hill farmers. The traditional methods of thresh-

ing and pearling do not encourage output and are often in low quality products (Singh *et al.*, 2003). This crop is harvested at 16 to 20 percent moisture content in the month of October-November and kept under the sun until the moisture content reduces to 10 to 12 percent, followed by staking the harvested crop for 1 to 1.5 months in a threshing yard for loosening the glumes of the grains. The mechanized threshing and pearling of finger millet could reduce the drudgery to farmers. Most of the hill farmers are small/marginal and can not afford to procure a separate machine for different processing operations like threshing, pearling and polishing. They require a low cost and light weight machine, which can perform multiple operations. In view of socio-economic conditions of the hill farmers, the large capacity threshers are inappropriate and even the small size but more sophisticated machines are difficult to be adopted (Grame, 1998).

A machine, Vivek thresher-1 (Fig. 2), was developed at Vivekananda Institute of Hill Agriculture (ICAR), Almora, Uttarakhand, India for threshing of millet. The threshing drum of the Vivek Thresher-1 was modified (Fig. 3) for versatile use and better capacity and efficiency at the Indian Institute of Technology, Kharagpur. The objective of the present study was to find the optimum machine parameters for efficient threshing and pearling operations of finger millet using neural network and genetic algorithm techniques.

## Materials and Methods

### Raw Material

The finger millet (variety, VL Mandua 149) panicles and grains used in this experiment were obtained from Vivekananda Institute of Hill Agriculture (ICAR), Almora, Uttarakhand, India. The seeds were

### Nomenclature

$R_d$	relative deviation percent, %	$T_E$	threshing efficiency, %
$Y_p$	predicted value of responses	$P_C$	pearling capacity, kg/h
$Y_e$	experimental value of responses	$P_E$	pearling efficiency, %
$N$	total number of experiments	$X$	real value of independent variables
$n_h$	number of hidden layer neurons	$F$	fitness value
$n_i$	number of input layer neurons	$b_0$	constant
$m$	number of bits in string	$b_i$	linear regression coefficient
$X_{max}$	maximum value of independent variable	$b_{ii}$	quadratic regression coefficient
$X_{min}$	minimum value of independent variable	$b_{ij}$	interaction regression coefficient
$a_d$	accuracy of variable	$k$	number of independent variables considered for optimization
$X_1$	number of canvas strips on periphery	$a_m$	extreme coded value (maximum = +am; minimum = -am)
$X_2$	over hanging width of canvas strip	CCRD	central composite rotatable design
$X_3$	peripheral speed of drum	ANN	artificial neural network
$x_1$	coded value of $X_1$	GA	genetic algorithm
$x_2$	coded value of $X_2$	$N_r$	number of random variables
$x_3$	coded value of $X_3$	$X_i$	actual value of ith variable
$T_C$	threshing capacity, kg/h	$x_i$	coded value of ith variable

Fig. 1 Traditional threshing and pearling of finger millet



cleaned by a cleaner-grader developed by the Central Institute of Agricultural Engineering, Bhopal, India using an appropriate set of sieves to remove foreign matters and immature seeds. The moisture content of the grain was 9.9 % d.b., as determined by the digital moisture analyzer (AND, model - MX-50).

### Finger Millet Thresher-Cum-Pearler

This machine was designed and developed at the Indian Institute of Technology Kharagpur, West Bengal, India, for its multiple uses like pearling along with threshing of finger millet. The over all dimensions of the machine were  $895 \times 613 \times 790$  mm. The frame of the machine was made of  $25 \times 25 \times 3$  mm MS angle. The weight of the machine with the prime mover was 46.4 kg. The threshing drum was rasp bar type, 172 mm long and 120 mm diameter. It was used with an appropriate make of circular fixed concave, covering  $110^\circ$  of cylinder circumference fabricated from twisted 6 mm MS round bar with 5 mm outlet and 3 mm inlet clearances. Eight MS strips, 25 mm wide and 190 mm long, were welded on the threshing drum along the length.

A pictorial view of the threshing/pearling drum is given in Fig. 3. On these MS flats, canvas flats 20 mm wide and 190 mm long, were fitted such that some width of canvas remained exposed to the grain, which provided abrasive action and soft impact for threshing and removing the glumes from the grains. The shaft of the drum was made of a round bar 24 mm diameter and 365 mm long. A variable diameter V-groove pulley was used for changing the drum speed.

The feeding chute was fabricated from 1.5 mm thick mild steel sheet. A blower with four fan blades mounted on a 17.5 mm diameter shaft and supported by ball bearings (6202), 90 mm long and 70 mm wide, was fabricated from 1.5 mm MS sheet. An airflow control device was made from 1.5 mm thick MS sheet.

### Experimental Design

#### Fractional factorial experiment

The important machine parameters that affect the threshing and pearling capacity and efficiency of the machine were number of canvas strips over the drum periphery ( $X_1$ ), overhanging width of canvas ( $X_2$ ), peripheral speed of canvas strip tip

( $X_3$ ), thickness of canvas strip ( $X_4$ ) and total width of canvas strip ( $X_5$ ). Initially a fractional factorial experiment was conducted with the above five independent variables viz.,  $X_1$ ,  $X_2$ ,  $X_3$ ,  $X_4$  and  $X_5$ , for which coded values (between +1 to -1) were  $x_1$ ,  $x_2$ ,  $x_3$ ,  $x_4$  and  $x_5$ , respectively. The total number of factorial experiments with five independent variables were 32. Here, two sacrificing interactions were taken for screening eight experiments (one-fourth of the total) (Myers, 1971). This way, only eight factorial experiments (Table 1) were conducted with five independent variables for threshing capacity ( $T_C$ ), threshing efficiency ( $T_E$ ), pearling capacity ( $P_C$ ) and pearling efficiency ( $P_E$ ).

#### Central Composite Rotatable Design (Ccrd)

The results of a fractional factorial experiment design with three independent variables viz.,  $X_1$ ,  $X_2$  and  $X_3$  were finally considered for the CCRD experiment. The experimental plan for optimization constituted four dependent variables viz.,  $T_C$ ,  $T_E$ ,  $P_C$  and  $P_E$ . For this purpose, response surface methodology (RSM) using a Central Composite Rotatable Design (Hunter, 1959; Rastogi *et al.*, 1998) to fit a second

Fig. 2 Line diagram of Vivek thresher-1

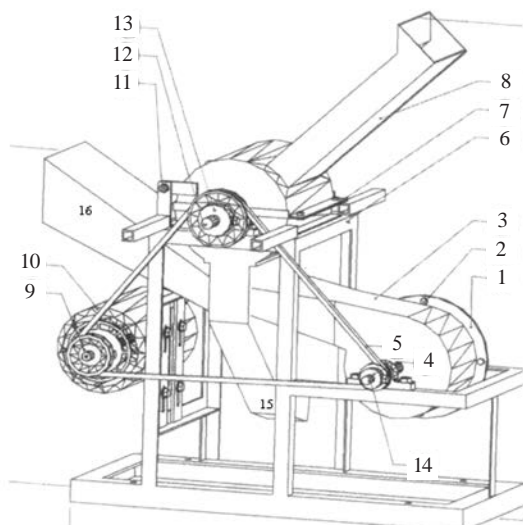

- 1: Side cover of blower; 2: Nut-bolt fitting of blower cover; 3: Blower body;
- 4: Frame; 5: V-belt; 6: Transporting grip; 7: Nut-bolt fitting of upper housing;
- 8: Feeding chute; 9: Motor shaft; 10: 1 hp electric motor;
- 11: Upper housing opening pivot; 12 and 13: V-belt pulleys;
- 14: Blower pulley; 15: Grain outlet chute; 16: Hull outlet chute

Fig. 3 Threshing-cum-pearling drum

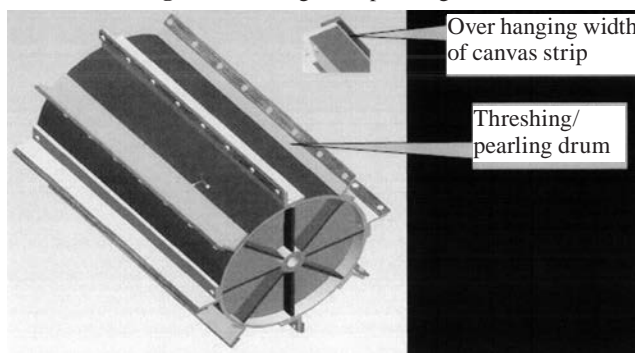

- Over hanging width of canvas strip
- Threshing/pearling drum

order polynomial eqn. was employed for threshing and pearling of finger millet. Values of  $X_1$  varied from 3 to 10,  $X_2$  between 0 to 6 mm and  $X_3$  between 5 to 9 m/s. In the design (Table 2) the real values of the independent variables,  $X_1$ ,  $X_2$  and  $X_3$ , were coded (Eqns. 1 to 4) as  $x_1$ ,  $x_2$  and  $x_3$  having values within the range of +1.682 to -1.682.

$$x_i = \frac{X_i - X_m}{X_D} \dots\dots\dots (1)$$

Here  $i = 1, 2$  and  $3$

$$X_D = \frac{X_{max} - X_m}{a_m} \dots\dots\dots (2)$$

$$X_m = \frac{X_{max} + X_{min}}{2} \dots\dots\dots (3)$$

$$a_m = 2^{0.25k} \dots\dots\dots (4)$$

Non linear second order regression eqns of the form of Eqn. 5 for the responses as a function of coded values of the independent parameters were developed and machine parameters were optimized for maximizing the TE, TC, PC and PE using MATLAB 7.0.

$$Y_p = b_0 + \sum_{i=0}^3 b_i x_i + \sum_{i=1}^3 b_{ii} x_i^2 + \sum_{i=1}^2 \sum_{j=i+1}^3 b_{ij} x_i x_j \dots\dots\dots (5)$$

The goodness of fit of the developed nonlinear eqns was tested by relative deviation percent (Rd). The value of Rd was calculated by Eqn. 6.

$$Rd = \frac{100}{N} \sum_{N=1}^N \left| \frac{Y_p - Y_e}{Y_e} \right| \dots\dots\dots (6)$$

The independent variables were fixed at five levels as per the CCRD type experimental design and a total number of 20 experiments were conducted as shown in Table 2. The experiments were conducted in random order. Six repeated experiments were conducted at the central points of the coded variables to calculate the error sum of squares and the lack of fit of the developed regression eqn. between the responses and independent variables (Myers, 1971).

**Artificial Neural Network Modeling (Ann)**

The most popular method to perform the ANN learning is the feed

**Table 1** Fractional factorial experimental design of finger millet threshing/pearling with five independent variables

Independent variables					Responses			
$X_1$	$X_2$ , mm	$X_3$ , m/s	$X_4$ , mm	$X_5$ , mm	Tc, kg/h	TE, %	Pc, kg/h	PE, %
10	6	9	6	35	98.8	64.8	98.8	36.5
10	6	9	2	20	98.5	65.2	98.6	34.6
10	0	5	6	20	96.7	63.7	96.7	36.8
10	0	5	2	35	96.4	63.6	96.5	35.3
3	6	9	6	20	94.6	61.5	96.7	32.4
3	6	9	2	35	94.5	61.7	97.1	33.6
3	0	5	6	35	92.7	59.6	96.1	31.9
3	0	5	2	20	92.3	59.2	96.3	30.5

**Table 2** CCRD experiment for finger millet threshing/pearling with three independent variables

Independent variables			Responses			
$X_1$	$X_2$ , mm	$X_3$ , m/s	Tc, kg/h	TE, %	Pc, kg/h	PE, %
6 (0)	3.00 (0)	5.00 (-1.68)	32.50	97.30	61.20	96.80
6 (0)	0.00 (-1.68)	7.00 (0)	35.20	98.20	63.20	96.20
8 (+1)	4.78 (+1)	8.19 (+1)	33.10	97.50	65.20	98.70
10 (+1.68)	3.00 (0)	7.00 (0)	32.10	97.00	64.20	97.30
6 (0)	3.00 (0)	7.00 (0)	35.30	99.30	63.70	96.20
6 (0)	3.00 (0)	7.00 (0)	35.50	99.50	63.10	98.90
4 (-1)	4.78 (+1)	8.19 (+1)	34.70	98.90	63.50	98.10
6 (0)	3.00 (0)	7.00 (0)	35.00	99.20	64.20	98.40
6 (0)	3.00 (0)	7.00 (0)	36.30	99.20	63.90	98.60
8 (+1)	1.22 (-1)	5.81 (-1)	32.70	97.20	62.30	95.40
8 (+1)	1.22 (-1)	8.19 (+1)	33.30	97.60	64.70	97.30
3 (-1.68)	3.00 (0)	7.00 (0)	33.60	97.10	63.20	95.10
4 (-1)	4.78 (+1)	5.81 (-1)	32.70	97.70	62.30	94.10
8 (+1)	4.78 (+1)	5.81 (-1)	32.20	97.10	63.40	94.70
4 (-1)	1.22 (-1)	5.81 (-1)	33.10	97.20	63.10	94.20
6 (0)	3.00 (0)	7.00 (0)	34.90	98.60	63.70	98.70
6 (0)	3.00 (0)	7.00 (0)	35.20	98.50	63.70	98.50
6 (0)	3.00 (0)	9.00 (+1.68)	35.30	98.50	64.70	98.60
4 (-1)	1.22 (-1)	8.19 (+1)	34.30	98.60	63.80	98.30
6 (0)	6.00 (+1.68)	7.00 (0)	33.80	98.70	64.10	98.00

forward and back propagation neural network; the error of the output was back propagated from the output layer to the hidden layers and, finally, to the input layer (Baughman and Liu, 1995). A multilayer feed forward neural network was designed in MATLAB (Demuth and Beale, 1998) using back propagation algorithms and supervised learning for predicting the non-linear relationship between the inputs and outputs. Input data were coded between +1 and -1 and the responses Y were coded between 0 and 1.

The neural network design consisted of three input neurons  $n_i$  corresponding to three independent variables ( $X_1, X_2$  and  $X_3$ ) and 4 output neurons  $n_o$  corresponding to four dependent variables ( $T_C, T_E, P_C$  and  $P_E$ ). One hidden layer was used since this was generally sufficient to approximate any continuous non-linear function (Xie and Xiong, 1999). The number of hidden layer neurons  $n_h$  was five, which was calculated using Eqn. 7.

$$n_h = 2 \times n_i - 1 \dots\dots\dots(7)$$

Fig. 4 presents the basic structure of the multilayer feed forward net-

work used in the present problem. **Genetic Algorithms (Ga) Modeling for Optimization of Variables**

Instead of using the trial and error procedure, different GA approaches may be used to optimize the parameters of neural networks (Ferentinos, 2005; Liu *et al.*, 2007; Sarimveis *et al.*, 2004). A genetic algorithms model (Shopova and Vaklieva-Bancheva, 2006) was developed in MATLAB to find out the optimum levels of independent variables. The final trained and tested neural network model was used for predicting the responses required in the genetic algorithms modeling. Fig. 5 shows the schematic representation of the procedure for optimization using neuro-genetic algorithms. Genetic algorithm modeling consisted of binary encoding of the independent variable, fitness function evaluation, GA operation (reproduction, crossover and mutation) and error calculation. The first step of the GA modeling was the binary coding of three independent variables. In this encoding, the independent variables were represented as a string of binary digits 0 and 1. The maximum

binary value of a string of length  $m$  is  $2^m-1$ . An independent variable  $X$  was coded by a  $m$  bit string containing number 0 and 1 by using the following relation ship.

$$m = \log_e \left[ \left( \frac{X_{max} - X_{min}}{2ad} + 1 \right)^{\log_e 2} \right] \dots\dots(8)$$

The value of  $ad$  was taken as  $\pm 0.01$  for variable  $X_1$ , 0.001 for  $X_2$  and 0.001 for  $X_3$ . Eqn. 8 was used for estimating string length  $m_1, m_2$  and  $m_3$  of the three independent variables. The value of  $m$  was taken as a whole number closer to the number obtained from calculation. Through random number generation, a series of population strings containing  $m_1 + m_2 + m_3$  number of 0 and 1 was developed first. The population string developed was a matrix of  $N_r$  rows and  $m$  columns, when a single row of this matrix was divided into three matrices containing  $m_1, m_2$  and  $m_3$  elements.  $N_r$  can be expressed as Eqn. 9.

$$N_r = 1.65 \times 2^{0.21m} \dots\dots\dots(9)$$

If  $v_b$  is the binary value of the segmented population strings of length  $m$  and  $X_{max}$  and  $X_{min}$  are, respectively, the maximum and minimum values of the independent variables

Fig. 4 Basic structure of the designed feed forward back propagation neural network

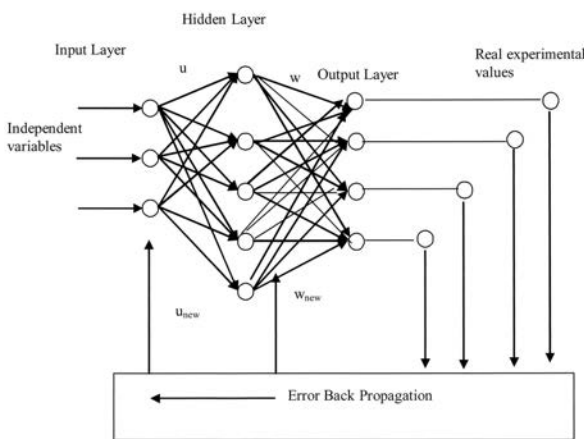
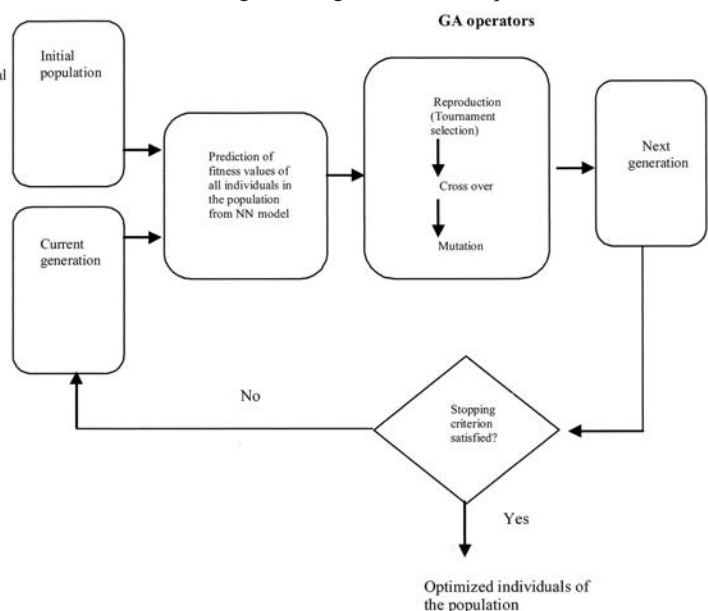

Fig. 5 Procedure of optimization using coupled neural network and genetic algorithms technique



associated with the string, the real value  $X$  of the variable can be expressed as **Eqn. 10**,

$$X = X_{min} + \left( \frac{X_{max} - X_{min}}{2^m - 1} \right) V_b \dots (10)$$

Our objective was to find the value of  $X_1$ ,  $X_2$  and  $X_3$  that would give the maximum possible values of outputs  $Y_1$ ,  $Y_2$ ,  $Y_3$  and  $Y_4$ . Each of the population strings was evaluated against a 'fitness' or objective function. One of the various ways of expressing the 'fitness' function  $F$  in this case was expressed as **Eqn. 11**.

$$F = y_{01} + y_{02} + y_{03} + y_{04} \dots (11)$$

All other steps were followed according to **Fig. 5** and optimized independent variables along with predicted values of dependent variables were obtained.

## Results and Discussion

### Fractional Factorial Experiment

The following linear regression **Eqns. 12, 13, 14** and **15** in terms of coded values (+1 to -1) were developed by calculating the coefficients in MATLAB 7.0. Two independent variables had to be removed for reducing the number of experiments using **Eqns. 12, 13, 14** and **15**.

$$T_C = 33.825 + 1.725x_1 + 0.075x_2 + 0.125x_3 + 1.025x_4 + x_5 \dots (12)$$

$$T_E = 97.1 + 0.55x_1 + 0.2x_2 + 0.5x_3 - 0.025x_4 + 0.025x_5 \dots (13)$$

$$P_E = 95.567 + 2.0325x_1 + 0.475x_2 + x_3 + 0.125x_4 + 0.04x_5 \dots (14)$$

$$P_C = 62.417 + 1.9x_1 + 0.3875x_2 + 0.5x_3 + 0.0125x_4 - 0.015x_5 \dots (15)$$

First, variable  $x_5$  was chosen to be eliminated since its corresponding coefficients were lowest in **Eqns. 13, 14** and **15**. The coefficients of  $x_4$  appeared to be lowest in **Eqns. 13** and **15**. As a result, it was decided to eliminate the variable  $x_4$ . The coefficients of  $x_2$  were lowest in **Eqn. 12** only and, hence, it was not eliminated. Finally, independent variables  $x_4$  (thickness of canvas strip) and  $x_5$  (total width of canvas strip) were eliminated from further (CCRD) experiments.

### Linear Regression Eqn. with Selected Machine Parameters

In order to find the effect of various machine parameters as threshing and pearling capacity and efficiencies, four linear regression eqns (in terms of coded value +1 to -1) were developed by calculating the coefficients in MATLAB 7.0 (**Eqns 16, 17, 18** and **19**).

$$T_C = 33.93 - 0.83x_1 - 0.38x_2 + 1.16x_3 \dots (16)$$

$(R_d = 2.59)$

$$T_E = 97.78 + 0.68x_1 - 0.93x_2 - 0.44x_3 \dots (17)$$

$(R_d = 1.39)$

$$P_C = 63.55 + 0.34x_1 + 0.25x_2 + 1.48x_3 \dots (18)$$

$(R_d = 0.63)$

$$P_E = 97.18 + 0.59x_1 + 0.42x_2 + 2.10x_3 \dots (19)$$

$(R_d = 1.08)$

Since the values of relative deviation percent of **Eqns. 16** to **19** were less than 10 %, the linear models developed were considered to have a good fit to the experimental data (Das, 2005).

The magnitudes of coefficients, which are the measure of effectiveness of variables ( $x_1$ ,  $x_2$  and  $x_3$ ) of **Eqns. 16, 17, 18** and **19**, were compared. It was evident from **Eqns. 16, 17** and **19** that the effect of  $x_3$  (drum speed) was maximum followed by  $x_1$  (number of rows of canvas strip on the periphery) and  $x_2$  (over hanging width of canvas strip) on threshing and pearling capacity and efficiency. However, in **Eqn. 17** it was observed that the effect of variable over hanging width of canvas strip was maximum followed by number of rows of canvas strip on periphery and drum speed on threshing efficiency.

### Non Linear Regression Eqns.

Non-linear second order regression eqns were developed as a function of coded values of independent parameters viz.,  $x_1$ ,  $x_2$  and  $x_3$  for the 4 dependent variables viz.,  $T_C$ ,  $T_E$ ,  $P_C$  and  $P_E$ . The developed relationships are given in **Eqns. 20, 21, 22**

and **23**.

$$T_C = 35.22 - 1.16x_1 - 0.41x_2 + 1.07x_3 - 2.54x_1^2 - 1.15x_2^2 - 1.75x_3^2 - 0.26x_1x_2 - 0.63x_2x_3 + 0.39x_3x_1 \dots (20)$$

$$T_E = 99.20 + 0.30x_1 - 0.51x_2 - 0.06x_3 - 0.286x_1^2 - 1.30x_2^2 - 1.85x_3^2 + 2.95x_1x_2 + 2.65x_2x_3 - 3.26x_3x_1 \dots (21)$$

$$P_C = 63.79 + 0.27x_1 + 0.39x_2 + 1.60x_3 - 0.49x_1^2 + 0.10x_2^2 - 0.60x_3^2 + x_1x_2 + 0.85x_2x_3 - 0.04x_3x_1 \dots (22)$$

$$P_E = 98.24 + 0.31x_1 + 0.48x_2 + 1.98x_3 - 2.18x_1^2 - 1.45x_2^2 - 0.85x_3^2 + 0.37x_1x_2 - 0.81x_2x_3 + 0.71x_3x_1 \dots (23)$$

The relative deviation percent of the developed models as calculated by **Eqn. 6** were 2.59, 1.39, 0.63 and 1.08 for  $T_C$ ,  $T_E$ ,  $P_C$  and  $P_E$ , respectively. Since the values of relative deviation percent were less than 10 %, the non linear models developed were considered to have a good fit to the experimental data (Das, 2005).

### Relative Deviation Percentage from Neural Network Modeling

The designed neural network was trained for different iterations ranging from 1,000 to 50,000 using varying combinations of learning coefficients (0.65, 0.70, 0.75 and 0.80). Each combination was trained 25 times. Since the random number generation method was employed in creating the weight matrices, different mean relative deviation percents for the predicted and actual values of dependent parameters for all these combinations ranged between 0.29 to 0.61 %. It was observed that relative deviation percentage decreased with increase in number of iterations for all learning coefficients. However, there was no definite influence of learning coefficient on the relative deviation percent.

The minimum relative deviation percent was observed at a learning coefficient of 0.75 for the number of iterations of 50,000, which was selected as the optimum values of neural network parameters. **Figs.**

6-9 show the comparison between the experimental and predicted responses at the optimum neural network parameters (experiment numbers as given in **Table 2**). The relative deviation percent values for the individual responses (0.61 % for  $T_C$ , 0.47 for  $T_E$ , 0.30 for  $P_C$  and 0.29 for  $P_E$ ) yielded a mean value of 0.42 %, which comes out to be the lowest.

### Optimization of Independent Variables Using Genetic Algorithms Modeling

Optimization of independent variables was based on maximization of

the amount of  $T_C$ ,  $T_E$ ,  $P_C$  and  $P_E$ . It was achieved using a program developed in MATLAB 7.0 using neural network and genetic algorithm techniques. Optimum combination of independent variables obtained from the neural network and genetic algorithm ( $X_1 = 8$ ,  $X_2 = 5.17$  mm and  $X_3 = 7.97$  m/s) were utilized for developing the new machine. The responses at optimum values of independent variables as obtained from the programme were 33.21 kg/h, 97.90 %, 65.12 kg/h and 98.60 % for  $T_C$ ,  $T_E$ ,  $P_C$  and  $P_E$ , respectively. The new machine with the optimized set of machine parameters

was tested and the difference between the predicted maximum values of responses and the responses obtained for the independent variables combination ( $T_C = 32.40$  kg/h,  $T_E = 98.41$  %,  $P_C = 65.00$  kg/h and  $P_E = 98.30$  %) were very small.

### Conclusions

It was evident from the fractional factorial experiment that the independent machine parameters viz., number of canvas strips on the periphery of the drum ( $X_1$ ), over hanging width of canvas ( $X_2$ ) and

**Fig. 6** Comparison of experimental and neural network predicted values of threshing capacity

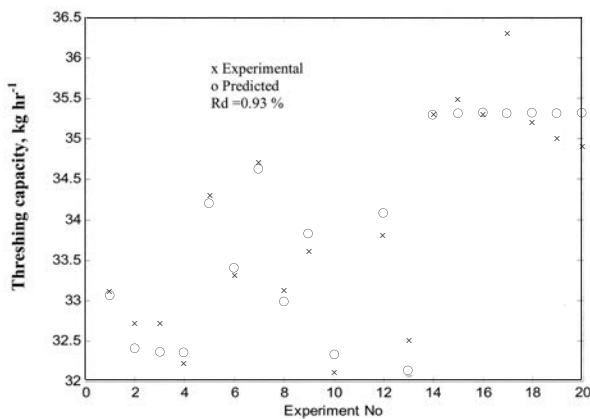

**Fig. 7** Comparison of experimental and neural network predicted values of threshing efficiencies

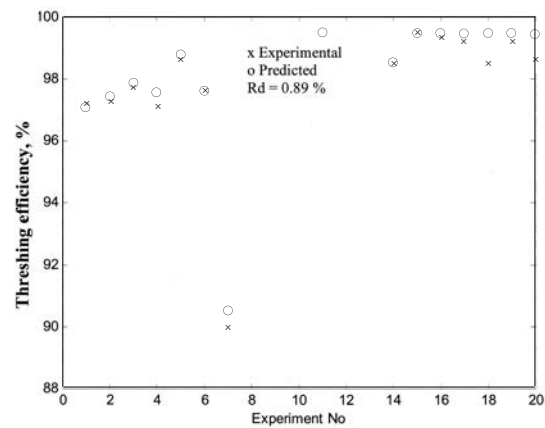

**Fig. 8** Comparison of experimental and neural network predicted values of pearling capacities

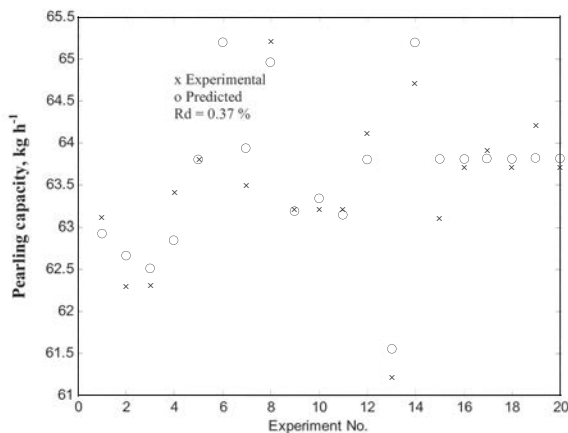

**Fig. 9** Comparison of experimental and neural network predicted values of pearling efficiencies

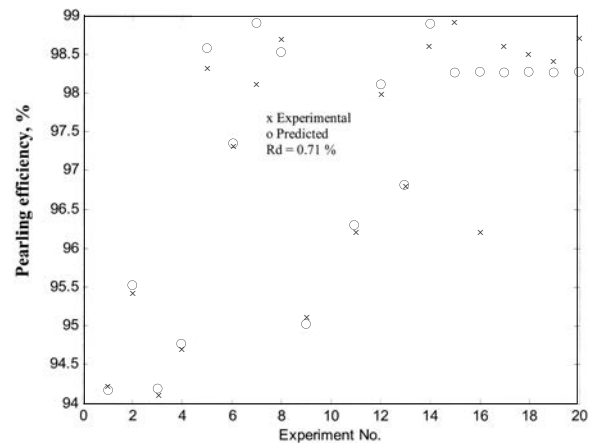



peripheral speed of canvas strip tip ( $X_3$ ), had more influence on machine performance as compared to thickness of canvas flat ( $X_4$ ) and total width of canvas flat ( $X_5$ ). By comparing the numerical values of coefficients of each linear eqn., it could be inferred that the effect of  $X_3$  was the highest on the responses  $T_C$ ,  $T_E$ ,  $P_C$  and  $P_E$  followed by  $X_2$  and  $X_3$ . The result of optimization revealed that the best combination of machine parameters were peripheral drum speed 7.97 m/s, overhanging width of canvas (5.17) mm and number of canvas strips over the drum periphery (8). The corresponding dependent parameters were threshing capacity, 32.4 kg/h, against, 33.21 kg/h, predicted; threshing efficiency, 98.41 %, against, 97.90 %, predicted; pearling capacity, 65.00 kg/h, against, 65.12 kg/h, predicted; and pearling efficiency, 98.30 %, against, 98.60 %, predicted. The developed ANNs were able to estimate with high accuracy the threshing capacity, threshing efficiency, pearling capacity and pearling efficiency of thresher-cum-pearler with any number of strips, on the drum periphery, over hanging width of canvas strips and peripheral drum speed. The developed genetic algorithm was a useful tool to improve the generalization capacity of the implemented neural networks.

## REFERENCES

- Anonymous. 2001. Grain of truth an analysis. Science and Environmental fortnightly magazine. 15 May. 31-41.
- Barbeau, W. E. and K. W. Hillu. 1993. Protein, calcium, iron and amino acid content of selected wild and domesticated cultivars of finger millet. *Plant Foods for Human Nutrition*. 43: 97-104.
- Baughman, D. R. and Y. A. Liu. 1995. Neural networks in bioprocessing and chemical engineering. United Kingdom: Academic Press Inc..
- Das, H. 2005. Food Processing Operation Analysis. 1st edition, Asian Book Private Limited, New Delhi, India.
- Demuth, H. and M. Beale. 1998. Neural network toolbox for use with MATLAB. Natick, MA. The Mathworks, Inc..
- Ferentinos, K. 2005. Biological engineering applications of feed forward neural networks designed and parameterized by genetic algorithms. *Neural Networks*. 18: 934-950.
- Gopalan, C., B. V. Ramasastri, and S. C. Balasubramanian. 1997. Nutritive value of Indian foods. National Institute of Nutrition, Indian Council of Medical Research, Hyderabad.
- Grame, R. Q. 1998. Global assessment of power threshers for rice. *Agricultural Mechanization in Asia, Africa and Latin America*. 29(3): 47-54.
- Hunter, J. S. 1959. Determination of optimum condition by experimental methods. *Indian Quality Control*. 15: 6-16.
- Liu, X., X. Cheng, W. Wu, and G. Peng. 2007. A neural network for predicting moisture content of grain drying process using genetic algorithm. *Food Control*. 18: 928-933.
- Malleshi, N. G. 1986. Processing of small millets for food and industrial uses. In: *Proceeding of First International Small Millet Workshop*, Bangalore, October 29-November 2, 1986. Oxford and IBH. 321-324.
- Malleshi, N. G. 2005. Finger millet -the wonder grain. IFIS, www.ieis.org/fsc.ixid.
- Malleshi, N. G. and H. S. R. Desikachar. 1985. Milling, popping and malting characteristics of some minor millets. *Journal of Food Science and Technology* 22: 400
- Myres, R. H. 1971. Response surface Methodology. Boston: Allyn and Bacon.
- Rai, M. 2002. Coarse Cereals: Productivity gains focus. *The Hindu Survey of Indian Agriculture*. pp. 53-55.
- Rao, M. A. 1986. Rheological properties of fluid foods. In M. A. Rao and S. S. H. Rizvi (Eds.), *Engineering Properties of Foods* (pp. 1-48). New York: Marcel Dekker, Inc.
- Rastogi, N. K., G. Rajesh, and T. R. Shamala. 1998. Optimization of enzymatic degradation of coconut residue. *Journal of Science and Food Agriculture*, 76: 129-134.
- Sarimveis, H., A. Alexandridis, S. Mazarakis, and G. Bafas. 2004. A new algorithm for developing dynamic radial basis function neural network models based on genetic algorithms. *Computers and Chemical Engineering* 28: 209-217.
- Sehgal, S. and A. Kwatra. 2003. Processing and utilization of pearl millet for nutrition security. *Recent Trend in Millet Processing & Utilization*. pp. 1-6. CCS HAU, Hissar, India.
- Singh, K. P., S. Kundu, and H. S. Gupta. 2002. Vivek thresher for madua and madira. Anonymous, Annual report. pp. 88-89. VPKAS (ICAR), Almora.
- Singh, K. P., S. Kundu, and H. S. Gupta. 2003. Development of higher capacity thresher for ragi/kodo. *Recent trend in millet processing and utilization*. pp. 109-116. CCS HAU, Hissar, India.
- Shopova, E. G. and N. G. Vaklieva-Bancheva. 2006. BASIC?A genetic algorithm for engineering problems solution. *Computers and Chemical Engineering*. 30: 1293-1309.
- Xie, G. and R. Xiong. 1999. Use of hyperbolic and neural network models in modeling quality changes of dry peas in long time cooking. *Journal of Food Engineering* 41: 151-162.

■ ■

# Evolving Quality Rice for Temperate Highlands

by

Asif B. Shikari

Assistant Professor (Plant Breeding)  
Rice Research and Regional Station,  
Khudwani SKUAST-K Kashmir 192 102  
INDIA  
asifshikari@gmail.com



Syed Zameer

Assistant Professor  
Division of Post Harvest Technology  
SKUAST-K Shalimar Kashmir 191 121  
INDIA



G. A. Parray

Associate Professor (Plant Breeding)  
Rice Research and Regional Station Khudwani  
SKUAST-K Kashmir 192 102  
INDIA  
parray\_2005@rediffmail.com

Gul Zafar

Associate Professor  
Division of Plant Breeding & Genetics  
SKUAST-K Shalimar Kashmir 191 121  
INDIA  
g\_zafar@rediffmail.com

## Abstract

Rice quality is determined by the contribution of physical, chemical and cooking properties of rice kernels and their interactions. The experimental materials included six basmati type and four non-basmati varieties, which were used to study fourteen quality traits and their genetic correlations at the Rice Research and Regional Station, Khudwani (SKUAST-K), Kashmir, India, in the year 2007. Among the characters studied amylose content (AC) exhibited very high significant positive correlation with kernel length (KL), kernel length after elongation (KLAC), alkali spreading value (ASV) and volume expansion ratio (VER). Gel consistency (GC) showed negative significant association with AC, ASV and KL. High and low score for aroma after cooking was sensed for Pusa sugandh-3 and Mushk Budji, respectively. Based on the simple correlation coefficients it was suggested that traits like KL, KLAC, kernel length-breadth ratio, AC, GC, ASV and VER, should be used in formulation

of selection indices for developing quality rice for the region.

## Introduction

Rice (*Oryza sativa* L.) is the staple diet of the people of Jammu and Kashmir state and is grown in 259,000 hectares with a productivity of 2.3 t ha<sup>-1</sup>. In the valley-temperate part of the state (5,000-7,500 ft amsl), only non-basmati, medium slender and short bold rices are grown (145,000 hectares). Hardly any basmati or basmati type variety is being grown because of non-preference for long grained flaky type rices and secondly due to late maturity under Kashmir conditions, of basmati varieties which are native of Haryana, Himachal, Uttar Pradesh and Punjab. However, in the last few years efforts are on to develop and popularize the fine grain aromatic basmati or basmati type varieties in the region which possess acceptable physico-chemical, cooking and eating properties and show timely maturity (within 140 DAS). Some of the basmati accessions from sub-

tropical parts of the country have been evaluated and were found to fit though they have shown some inconsistency in performance over locations and years particularly with respect to grain yield and maturity. In this connection basmati varieties are grown along local short bold aromatic rice cultures and have been compared for the various quality attributes under Kashmir conditions. Character associations have been studied to devise a selection criterion for development of long grained premium quality aromatic rices for the region which may turn future rice cultivation more profitable and remunerative for the farmers when non-basmati rice cultivation is becoming more competitive with lower net returns and income.

## Materials and Methods

Seed materials were comprised of six basmati type varieties viz., Pusa Sugandh-3, Pusa Sugandh-5, Pusa 2517-2-51-1, UPR 2268-5-1, HKR 2K-603, Ranbir Basmati and four non-basmati varieties, i.e. Shalimar

Rice-1 (popular high yielding variety of the region), Black Rice (collection), Mushk Budji and Kamad (local aromatic land races). A trial was made in Randomized Block Design with three replications and laboratory analysis carried out at the Rice Research and Regional Station, Khudwani (SKUAST-K), Kashmir, India, in 2007. Standard cultivation practices were adopted. The grain was harvested under dry conditions and grain moisture was brought to 14 %. Finely milled and polished kernels were subjected to quality analysis. The characters studied were amylose content (%), gel consistency (mm), alkali spreading value (score 0-7), kernel length and breadth (mm), length-breadth ratio, cooked kernel length (mm), kernel elongation ratio and volume expansion ratio. Amylose was determined by the procedure of Juliano (1971), and alkali spreading value worked out following Little *et al.* (1958). Gel consistency was determined by the method given by Cagampang *et al.* (1973). Volume expansion ratio was measured by the water displacement method. Five g of rice were placed in a 15 ml graduated cylinder before cooking and volume change noted. Again, 5 g of rice after cooking were placed in a 50 ml graduated cylinder to note the volume change. Volume expansion ratio was found by dividing cooked volume change by volume change for uncooked sample. In determining shape and size, kernels were grouped into (1) long slender (length greater or equal to 6 mm and length-breadth ratio greater or equal to 3 mm), (2) short slender (length < 6 mm and LBR greater or equal to 3 mm), (3) medium slender (length < 6 mm and LBR < 3 mm), (4) long bold (length > 6 mm, LBR < 3 mm) and (5) short bold (length < 6 mm and LBR < 2.5 mm) following the Systematic Evaluation System of IRRI (Anonymous, 1996). Aroma was estimated after cooking by panel test. Scoring for aroma, cooked kernel appear-

ance, cohesiveness and tenderness after cooking was carried out following Subbaiah (2005). Simple coefficients of correlation were computed using WINDOWSTAT-2005 version.

## Results and Discussion

Pusa sugandh-5 recorded highest amylose content (AC) followed by Pusa sugandh-3 and Pusa 2517-2-51-1. HKR 2K-603, Ranbir Basmati, Black Rice and Shalimar Rice-1 had intermediate amylose percentage (**Table 1**). Medium hard gels were formed by Pusa sugandh-3, Pusa sugandh-5 and Pusa 2517-2-51-1 while others showed soft gel consistency (GC). Among the basmati group intermediate alkali spreading value (ASV) was found for Pusa sugandh-3 and Ranbir basmati, which was a desirable trait and is indicative of gelatinization temperature in the range of 70-74 °C beyond which starch granules irreversibly change their structure and result in cooked rice kernels. Pusa sugandh-5 and Pusa sugandh-3 exhibited highest values for kernel length after cooking (KLAC), kernel elongation ratio (KER) and volume expansion ratio (VER). These varieties were white in appearance and possessed high degree of aroma after cooking. As expected from their high amylose and medium hard gels, they cooked with well separated kernels and became moderately hard upon cooling after cooking. This was in consonance with the findings of Bansal *et al.* (2006) according to whom the flaky, well separated rices have high amylose and tend to become hard upon cooling. If local aromatic land races were compared to basmati there was very low AC for Mushk Budji accompanied with moderate aroma compared to Pusa sugandh-3. Among the different rice genotypes studied presently Black Rice and Mushk Budji had long bold and short bold kernel shapes

respectively. Kamad and Shalimar Rice-1, both recorded medium slender kernel types. The other six genotypes, which were of basmati type, had long slender kernel shape. Pusa sugandh-3 and -5 exhibited strong aroma after cooking followed by UPR 2268-5-1 and Ranbir Basmati, which showed an optimum aroma score of 4 on 1-5 scale. Pusa 2517-2-51-1, HKR 2K-603, Mushk Budji and Kamad recorded mild aroma followed by very little aroma for Black Rice. No Scent was identified for cooked kernels of Shalimar Rice-1. Pusa sugandh-3 has been successfully grown under Kashmir conditions and was reported (in a separate study) to mature timely (140 DAS) with 6.2 t ha<sup>-1</sup> against 2.5 t ha<sup>-1</sup> of local Mushk Budji (Parry and Shikari, 2007).

The acceptable ranges fixed by the Directorate of Rice Research (ICAR), Hyderabad, India for various quality attributes of basmati rice are mentioned as follows. Kernel length and breadth should be greater and lesser than 6.61 mm and 2 mm, respectively. ASV should be 4 or 5 on 1-7 scale and KLAC and KER not less than 12 mm and 1.70 mm, respectively. Intermediate levels of amylose (20-25 %) are desirable for good cooking quality, which should be coupled with soft gel consistency values (gel length > 61 mm) if amylose falls above 25 %. Besides, VER greater or equal to 3 should be a character of consumer preference. To find a premium quality basmati variety, the experiment included Pusa sugandh-3, which satisfies all this criteria, followed by Pusa sugandh-5 which has high ASV. The former has amylose slightly higher than 25 % and has proved to have a good performance vis-à-vis grain yield and quality, as discussed above. The other four non-basmati grain types are clearly distinguished in light of the above scale (**Table 1**).

AC exhibited highly significant and positive correlation with kernel length (KL), KLAC, and ASV and

moderate but significant positive correlation with KER and VER (**Table 2**). Similar results were found by Juliano (1985). AC recorded negative and significant correlation with GC. This was found in conformity with the findings of Khatun *et al.* (2003). Rices with high AC cook flaky and dry and show high volume expansion and kernel elongation. Dry flaky rices tend to have hard cooked gels (< 40 mm gel length) and become hard upon cooling. High lengthwise expansion, flaky texture and hard gels are characteristic features of basmati rices. GC showed highly significant and negative correlation with KL, KLAC, ASV and AC. This supports the fact that long grain basmati types have harder gels, and those with harder gels generally have high amylose (25-32 %) (Chang and Li, 1981) and require more energy for cooking, i.e. have high gelatinization temperature (GT) and normally show longer cooked kernel length

(Dipti *et al.*, 2002). High ASV is indicative of low GT and vice versa. ASV exhibited significant and high positive correlation with AC, KL and KLAC and negative correlation with GC and KB. Besides ASV, KB recorded negative correlation with KLAC, VER and AC, which explains that basmati types, where KB is less, show more expansion and elongation on cooking and have more amylose. Urban people prefer varieties that expand more in length than breadth (Choudhury, 1979). Fine grain rices are graded as export quality rices and fetch premium prices in foreign and domestic markets. On the other hand high volume expansion is considered to be the good quality by the working class who do not care whether elongation is length or breadth wise. Also, this is the case in Kashmir region where more volume expansion is a favorite trait rather than more length wise elongation as preferred in other parts of India. High yielding variet-

ies, which are under cultivation in Kashmir, have intermediate amylose, intermediate GT and GC, since this is the most preferred range of chemical qualities. Therefore, the question remains relating to meeting out the quality standards of rice produced in the region by further development and popularization of existing long, fine grained, aromatic rice genotypes which have acceptable levels of these three chemical attributes. This would be achieved by framing an index of characters that would help in breeding such varieties. The need of the hour is to demarcate the pockets of the people who are ready to grow long grain, high or intermediate amylose, flaky or fluffy type rices, be it aromatic or non-scented, which are fit for domestic and foreign markets. GT is not going to be a problem since low GT basmatis would mean less energy utilization for cooking rice.

**Table 1** Physico-chemical, cooking and eating properties of rice varieties

	1	2	3	4	5	6	7	8	9	10
AC	26.78	29.42	26.16	25.20	20.38	22.29	21.00	18.42	14.53	23.56
GC	50.23	55.71	50.44	64.10	90.43	75.33	62.17	87.28	90.85	93.30
ASV	5	7	6	6	5	5	4	3	4	2
KL	7.56	8.23	7.50	7.49	7.18	6.86	6.11	5.52	4.75	5.80
KB	1.80	1.75	1.75	1.75	1.25	1.75	2.51	2.50	2.51	2.00
LBR	4.20	4.70	4.29	4.28	5.74	3.92	2.44	2.21	1.89	2.90
KLAC	15.23	17.00	12.41	11.20	11.53	10.55	10.00	8.75	7.50	10.54
KER	1.98	2.07	1.66	1.47	1.61	1.53	1.64	1.59	1.58	1.81
VER	4.39	4.41	3.14	3.50	4.38	3.14	2.31	3.16	2.94	3.61
APP	5	5	5	5	5	4	1	4	4	5
COH	5	4	5	4	5	5	3	3	3	4
TAC	3	2	5	3	3	2	4	4	4	3
Aroma	5	5	3	4	3	4	2	3	3	1
KS	LS	LS	LS	LS	LS	LS	LB	MS	SB	MS
DM	146.67	153.33	150.23	151.00	154.69	155.30	136.33	135.41	125.67	143.20

**Genotypes under study-** 1: Pusa Sugandh-3; 2: Pusa Sugandh-5; 3: Pusa 2517-2-51-1; 4: UPR 2268-5-1; 5: HKR 2K-603; 6: Ranbir Basmati; 7: Black Rice; 8: Kamad; 9: Mushk Budgi; 10: Shalimar Rice-1

**Abbreviations used-** AC: Amylose content (%); GC: Gel consistency (mm); ASV: Alkali Spreading Value; KL: Kernel length (mm); KB: Kernel Breadth (mm); LBR: Length Breadth Ratio; KLAC: Kernel Elongation After Cooking (mm); KER: Kernel Elongation Ratio; VER: Volume Expansion Ratio; DM: Days to maturity.

APP: Appearance: 1-White with black streaks; 2-White with brown streaks; 3-Red streaks; 4-Creamish white brown; 5-White. COH: Cohesiveness: 1-Very sticky; 2-Moderately sticky; 3-Slightly sticky; 4-Partially separated; 5-Well separated.

TAC: Tenderness on touching (on cooling after cooking): 1-Hard; 2-Moderately hard; 3-Moderately soft; 4-Soft; 5-Very soft

Aroma (after cooking): 1-No scent; 2-Other than basmati; 3-Mild; 4-Optimum; 5-Strong

KS: Kernel shape: LS-Long slender; LB-Long bold; MS-Medium slender; SB-Short bold

\*Panel test was carried out thrice by a group of 10 persons.

## Conclusion

It may be suggested that Pusa Sugandh-3 is a perfect nomination to be used as parent in development of an essentially derived basmati variety (EDV) for the temperate Kashmir region because, qualitatively, along with one other test entry, Pusa Sugandh-5, it has proven to satisfy the standards of premium quality basmati type variety in addition to its relatively stable grain yielding performance and maturity. Pusa sugandh-5, which had more KLAC than Pusa Sugandh-3, may be brought under crossing to yield fine grain aromatic derivatives. Ultimately, the traits of consumer preference involve the cooking parameters viz., KLAC, KER and VER and should be given a high weight in devising a selection index. Though, for farmers and millers, milling and HRR is a concern. On screening a large number of germplasm lines, AC and other chemical properties, which usually are associated with cooking qualities, need to be analyzed only after the lines have been short listed for KER and KLAC. Inheritance of aroma must be studied in presently used breeding materials that may help in development of aromatic varieties with the materials in hand as a base material. The aroma is not always liked by the whole sect of people, therefore, repositories of fine grained non-aromatic rices may be an area of interest. Character associations devised may be useful for

generating correlated response from selection of more heritable traits for improving traits with low heritability. However, path analysis may be attempted with an even larger number of genotypes. Such like procedures will hasten the breeding of quality rice for local markets of the Kashmir region and markets outside in general.

## REFERENCES

Anonymous. 1996. Standard Evaluation System, INGER Genetic Resources Center, 4th ed. IRRI, Philippines.

Bansal, U. K., H. Kaur, and R. G. Saini. 2006. Donors for quality characteristics in aromatic rice. *Crop Improvement* 43(3): 197-202.

Cagampang, G. B., C. M. Perez, and B. O. Juliano 1973. A gel consistency test for eating quality of rice. *J. Sci. Food and Agri.* 24(1): 589-94.

Chang, W. L. and W. Y. Li. 1981. Inheritance of amylose content and gel consistency in rice. *Botan. Bull. Acad. Sinica.* 22: 35-47.

Choudhury, N. H. 1979. Studies on quality of rice in Bangladesh. In: *Proceedings of the workshop on chemical aspects of rice grain quality.* IRRI, Los Banos, Philippines, pp: 123-127.

Dipti, S. S., S. T. Hossain, M. N. Bari, and K. A. Kabir. 2002. Physicochemical and cooking properties of some fine rice varieties.

*Pakistan Journal of Nutrition.* 1(4): 188-190.

Parray, G. A. and Asif B. Shikari. 2007. Agricultural production strategies in Jammu and Kashmir State. In: *National Symposium on Research Priorities and Strategies in Rice Production System for Second Green Revolution.* Nov. 20-22, CRRI, Cuttack, pp: 147.

Juliano, B. O. 1971. A simplified assay for milled rice amylose. *Cereal Science Today* 16: 334-338, 340, 360.

Juliano, B. O. 1985. Polysaccharides, proteins and lipids of rice. In: *Rice Chemistry and Technology* (B. O. Juliano ed.) 2nd edition. Am. Assoc. Cereal Chem. St. Paul. pp: 59-179.

Khatun, M. M., M. H. Ali, and Q. D. Cruz. 2003. Correlation studies on grain physicochemical characteristics of aromatic rice. *Pakistan Journal of Biological Sciences,* 6(5): 511-513.

Little, R. R., G. B. Hilder, and E. H. Dawson. 1958. Differential effect of dilute alkali on 25 varieties of milled white rice. *Cereal chemistry.* 35: 111-126.

Subbaiah, S. V. 2005. Laboratory Manual on Rice Grain Quality Procedures. In: *Training for officials of Export Inspection Council of India, New Delhi, held at Directorate of Rice Research, Rajendra Nagar, Hyderabad, 24-30, August, pp: 14-17.*

■ ■

**Table 2** Genotypic correlations among important quality attributes of rice

	KL	KB	KLAC	KER	VER	GC	ASV	AC
KL		-0.78**	0.85**	0.40	0.60**	-0.72**	0.79**	0.91**
KB			-0.57*	-0.15	-0.73**	0.20	-0.56*	-0.55*
KLAC				0.82**	0.73**	-0.65**	0.65**	0.87**
KER					0.62**	-0.34	0.25	0.56*
VER						-0.03	0.38	0.49*
GC							-0.75**	-0.76**
ASV								0.61**
AC								

\*\* and \* indicate statistical significance at P (0.01) and P (0.05), respectively.

# Estimating Reliability for Redundant Agricultural Machinery Systems

by  
Kunihiro Tokida  
Senior Advisor,  
Japan International Cooperation Agency  
10-5 Ichigaya-Honmura-cho, Shinjuku-ku, Tokyo,  
162-8433  
JAPAN

## Abstract

System reliability eqns for redundant systems such as parallel-series, series-parallel, or their combined systems were reviewed from previous studies. The concepts of the redundant systems with conditions were illustrated using Venn diagrams. For wider application in agricultural machinery management, the concept of conditional parallel was studied. Examples of reliability estimation were calculated to show how the principles evolve machinery management.

## Introduction

ASAE Standard EP456 (1991) defined reliability as the probability that a part, assembly or system will perform satisfactorily for a specified period of time under specified operating conditions. Two reliability figures of merit were listed in the same ASAE standard; failure rate and mean time between failures (MTBF). The failure rate was the number of failures of an item per unit time. MTBF was the total operating time of a population of a product divided by the total number of failures.

Reliability of redundant systems

such as parallel-series, series-parallel, or their combined systems was analyzed by electrical engineers (Myers *et al.* 1964). Shoup (1982) presented techniques for estimating the reliability of complex agricultural machinery systems. Redundant units in parallel possessing different reliability values were termed as heterogenous machinery “backup” units, and their management implications were discussed. Barlow and Heidtmann (1984) presented a simple, exact algorithm for calculating the reliability of a k-out-of-n:G system (the system is good if and only if at least k of its n components are good).

Hunt (1971) reported that the average Midwest corn and soybean farmer had less than a 50 % probability of getting through the season without a breakdown that had a timeliness cost associated with it. Hunt (1971) also provided that the average Midwest corn and soybean farmer averaged 47.3 ha of corn and 26.5 ha of soybeans, and had a breakdown probability of 0.109 per 40.5 ha of use for spring tillage. The average breakdown time for farms over 202.3 ha was 13.56 hours with a standard deviation of 24.06 hours.

## Objective

The purpose of this paper is to review system reliability of redundant machinery systems that can be applied as a parameter when designing a field machinery system.

## System Reliability of Independent Components

Two reliability figures of merit, failure rate and mean time between failure (MTBF) were listed in the ASAE Standard EP456 (1991). The failure rate is the number of failures of an item per unit of cumulative time. MTBF is the total operating time of population of a product divided by the total number of failures, in other words, the inverse of failure rate. Any system can be modeled by combining its elements. Systems with repairable components in series are more typical of agricultural machinery, in which a failure of one component will disable the function of whole system. The failure rate of a system comprised of n components in series is the sum of the component failure rates.

$$\lambda_{system} = \lambda_1 + \lambda_2 + \dots + \lambda_n \quad (1)$$

where

$\lambda_{system}$  = system failure rate

$\lambda_n$  = failure rate of component n

The failure rate of a system com-

prised of 2 components in parallel is defined by the following eqn.:

$$\lambda_{system} = 1 / \{ (1 / \lambda_1) + (1 / \lambda_2) - [1 / (\lambda_1 + \lambda_2)] \} \dots \dots \dots (2)$$

The assumptions for these eqns (1) and (2) are that the components and the system are 2-state (operational or not operational) and that the components states are independent. This is, failure of one component does not affect the reliability of the other components. When a tractor is aging, gradual reduction of its power is not considered as a failure as long as the tractor remains operational and productive. Performance of some tractor parts is dependent on other parts, and Eqn. 1 and 2 may not be applied to these dependent parts.

The reliability of a component during its useful life time period is described by the single parameter exponential distribution:

$$R(t) = e^{-\lambda t} \dots \dots \dots (3)$$

Where:

R(t) = reliability

e = base of the natural logarithm

$\lambda$  = failure rate

t = time of use

System reliability is defined as the probability that a system will perform its function satisfactorily for a specified period of time under specified operating conditions. The system reliability of a system in series is obtained by multiplying reliability of each component as follows:

$$R_{system} = R_1 \times R_2 \times \dots \times R_n \dots \dots \dots (4)$$

Where:

R<sub>n</sub> = reliability of component n

Reliability of redundant systems such as series-parallel, parallel-series, or some other combination of parallel and series systems is commonly used in electrical and electronics engineering fields.

The equivalent reliability of a series-parallel system is:

$$R_{system} = [1 - (1 - R)^m]^n \dots \dots (5)$$

Where:

m = number of components in parallel unit

n = number of parallel units in series

R = reliability of an individual component

The equivalent reliability of a parallel-series system is:

$$R_{system} = 1 - (1 - R^n)^m \dots \dots (6)$$

where:

m = number of series units in parallel

n = number of components in a series unit

Barrow and Heidtmann (1984) presented a simple, exact algorithm for calculating the reliability of k-out of n:G system. Such a system is operational if at least k out of n components are operational. To obtain the probability that at least k components operate, expand and sum of coefficients of z<sup>j</sup> for j = k, ..., n by using the following generating

function:

$$g(z) = \prod_{i=1}^n (Q_i + R_i z) \dots \dots \dots (7)$$

Where:

R<sub>i</sub> = reliability of component i

Q<sub>i</sub> = unreliability of component i

z = dummy variable in generating function

n = number of components in system

k = minimum required number of operational components

Their algorithm assumed that the system is good if and only if at least k of its n components are operational in addition to the above two assumptions of two state and independence of components. Another assumption that each component in a parallel system has equal capacity must be applied for this calculation. This method can be utilized to esti-

Fig. 1 Graphical Representation of System Reliability

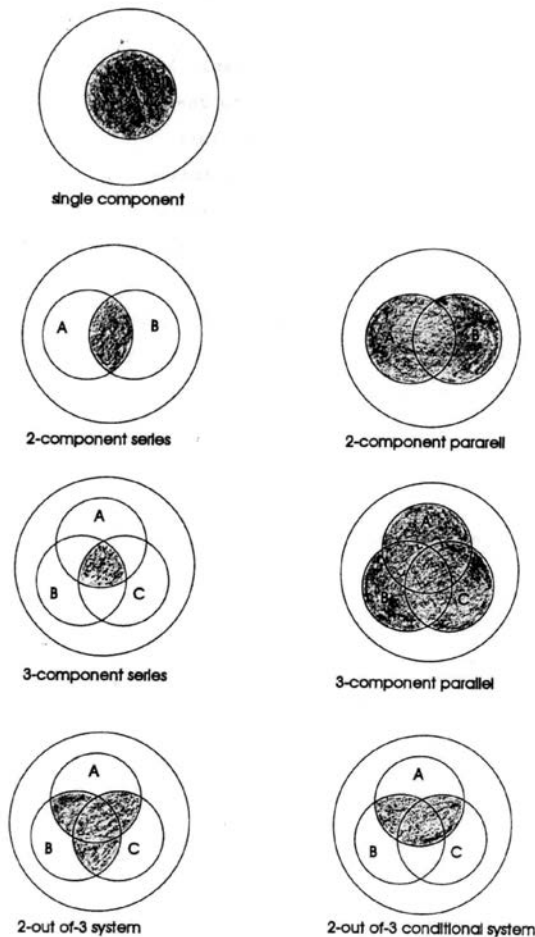

mate machinery system reliability when tractors are treated as independent components.

A graphical representation was made using Venn diagrams for easier interpretation of system reliability including the k-out-of-n:G redundant system in Fig. 1. The shaded areas in the figures show the probability of the system to be operational. Any combination of 2 units can perform the work. In the 2-out-of-3 conditional system, A is obliged to work at any time but either B or C can backup each other.

### Examples of Production System Reliability

Shoup (1982) presented techniques for estimating the reliability of complex agricultural machinery systems as a parallel redundant system using the above mentioned Eqn. 6. The meaning of numbers of functions is considered to be the number of different tasks which can be performed by the system for different purposes. However, there is no relevant rationale to express the system reliability of such case by using Eqn. 6. Shoup (1982) performed a reliability estimation by giving a production system example shown in Table 1. He regarded this machinery system as a parallel-series system and estimated the system reliability by multiplying all of the subsystem reliabilities.

In the Subsystem 3 and 4, Shoup (1982) considered that the added backup wagon is the same as having three wagons that must perform 2 functions. He did his estimation of system reliability of this system as follows:

Subsystem 1

$$R_{ss1} = [1 - (1 - 0.83)^2]^2 = 0.91582$$

Subsystem 2

$$R_{ss(1,2)} = 0.85 + (1 - 0.85) \times 0.72 = 0.958$$

Subsystem 3 and 4

$$R_{ss(3,4)} = [1 - (1 - 0.90)^2]^2 = 0.9801$$

Subsystem 5

$$R_{ss5} = 0.85 + (1 - 0.85) \times 0.9158 = 0.9874$$

$$R_{system} = 0.9158 \times 0.958 \times 0.9801 \times 0.9874 = 0.8490$$

For the reliability calculation of subsystem 1,  $R_{ss1}$  should be  $0.832 = 0.6724$  if one tractor is operated for pulling a combine and the other one is used for dairy work at the same time. It is assumed that the assignment of work for each tractor does not affect system reliability when using Eqn. 6. It is incorrect that the principle of independence is violated in the calculation of reliability for subsystem 5 by multiplying reliability of subsystem 1. In the calculation of system reliability, reliability of each component should appear only once.

The example system should be interpreted as shown Fig. 2 or Fig. 3 depending on the interpretation of tractor use for the dairy operation. The tractor subsystem 1 assumed that the dairy operation was done while the harvesting operation was not being done, and that two 100 HP tractors were available for either pulling a combine or pulling a wagon to backup the small tractor. The tractor subsystem 2 assumed that one 100 HP tractor was used for the dairy operation and the other one was used to pull a combine for the harvesting operation, and the small tractor was used to pull a wagon, thus there was no redundancy.

Table 1 Example agricultural machinery system by Shoup (1982)

Subsystem (Component)	Available machines Units Type	Reliability
1 (A, B)	2 100 HP tractors *	0.83 each
2 (C, D)	2 peanut combines	0.85 and 0.72
3 (E, F)	2 wagons **	0.90 each
4 (G)	1 extra wagon to backup either	0.90
5 (H)	1 40 HP tractor to pull wagon ***	0.85

\* Either tractor can pull a combine, can backup small tractor or can be used for dairy work

\*\* One for behind combine, another for behind tractor

\*\*\* This tractor cannot backup a 100 HP tractor

Table 2 Combinations of four-component system model

Number of failure	Mode	Four-component system model						
		(a)	(b)	(c)	(d)	(e)	(f)	(g)
0	A B C D	*	*	*	*	*	*	*
1	A B C <u>D</u>	*	*	*	*	*	*	*
	A B <u>C</u> D	*	*	*	*	*	*	*
	A <u>B</u> C D	*	*	*	*	*	*	*
	<u>A</u> B C D	*	*	*	*	*	*	*
2	A B <u>C</u> <u>D</u>	*	*	*	*	*	*	*
	A <u>B</u> <u>C</u> <u>D</u>	*	*	*	*	*	*	*
	A <u>B</u> <u>C</u> D	*	*	*	*	*	*	*
	<u>A</u> <u>B</u> <u>C</u> D	*	*	*	*	*	*	*
3	A B C D	*	*	*	*	*	*	*
	A B C <u>D</u>	*	*	*	*	*	*	*
	A B <u>C</u> D	*	*	*	*	*	*	*
	A <u>B</u> C D	*	*	*	*	*	*	*
4	A B C D	*	*	*	*	*	*	*

\_ Underlined characters show components in failure,

\* Signs of applicable combinations for the system models



The system reliability should be calculated based on the above assumptions as follows:

Tractor subsystem 1  

$$R_{tsub1} = 0.83^2 \times 0.85 + 2(1 - 0.83) \times 0.83 \times 0.85 + (1 -$$

$$0.85) \times 0.83^2 = 0.9287$$

Tractor subsystem 2  

$$R_{tsub2} = 0.83^2 \times 0.85 = 0.5856$$

Combine subsystem 1  

$$R_{csub} = 0.85 \times 0.72 + (1 - 0.85) \times 0.72 + (1 - 0.72) \times 0.85 = 0.9580$$

Wagon subsystem 1  

$$R_{wsub} = 0.90^3 + 3(1 - 0.90) \times 0.90^2 = 0.9720$$

Total system 1  

$$R_{sys1} = R_{tsub1} \times R_{tsub1} \times R_{tsub1} = 0.9287 \times 0.9580 \times 0.9720 = 0.8650$$

Total system 2  

$$R_{sys2} = R_{tsub2} \times R_{tsub1} \times R_{tsub1} = 0.5856 \times 0.9580 \times 0.9720 = 0.5450$$

The above calculation did not consider any operator constraints, but the availability of operator should be considered in actual cases.

### Conditional Parallel System

The concept of conditional parallel was studied for wider application on agricultural machinery management. The conditional parallel system is defined as a system which has some components that must be operational for the system to be operational while the other components have redundancy. The system reliability of conditional parallel for a four component model should be calculated by adding applicable event probabilities among combinations as shown in **Table 2**. The probabilities that the system models given in **Table 2** will be operational are expressed by the shaded areas of **Fig. 4**. The lower case letters of the four-component system model in **Table 2** refer to the lower case letters of **Fig. 4**.

### Estimation of Reliability

The failure rate is defined as the number of failures per unit time. From the aspect of agricultural machinery management, it is suggested that the failure rate is not only a function of time but also a function of acreage by assuming that machine size is proportional to land

**Fig. 2** Reliability of System Model 1 in series

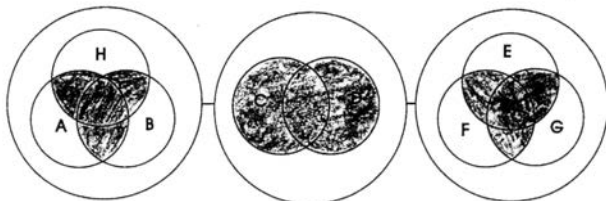

**Fig. 3** Reliability of System Model 2 in series

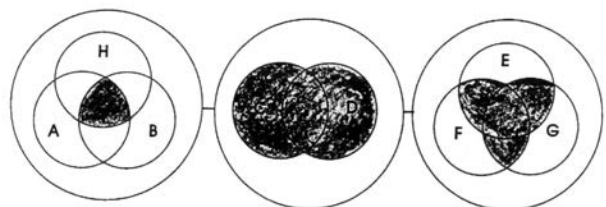

**Fig. 4** Reliability of Four-component System with conditions

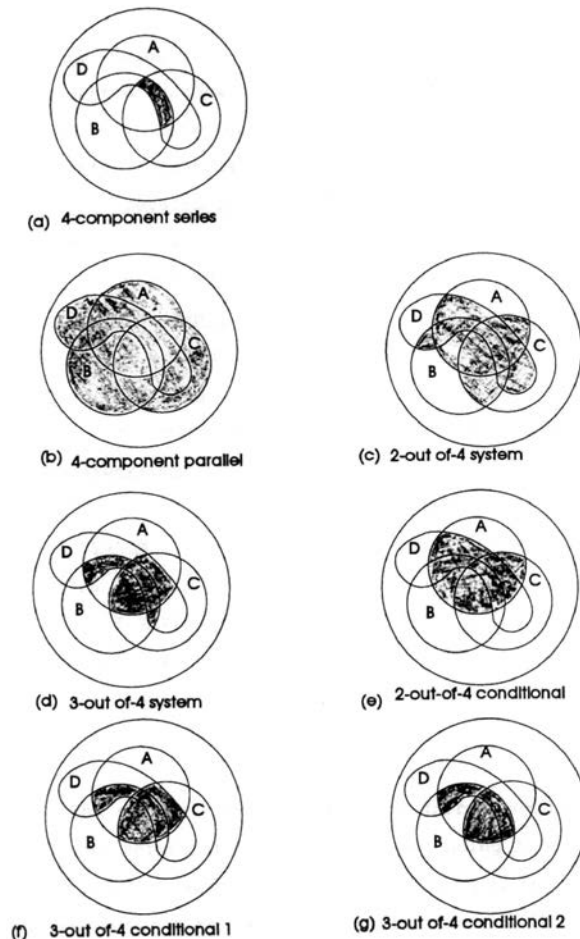

area covered by a machine.

Hunt (1971) reported that the average Midwest corn and soybean farmer averaged 47.3 ha of corn and 26.5 ha of soybeans, and had a breakdown probability of 0.109 per 40.5 ha of use for spring tillage. Thus, the failure rate was 0.269 per 100 ha. The average breakdown time for farms over 202.3 ha was 13.56 hours with a standard deviation of 24.06 hours. The expected land area for one failure during spring tillage was 372.3 ha. Hunt (1971) also provided the age of tractors in terms of calendar years and in terms of 500 hour-years in his paper. In this estimation, the average annual use was calculated from Hunt's data by dividing the total accumulated hour use obtained from 500 hour-year age (2,810,000 hours) by the total accumulated actual age (7431 years) of surveyed tractors, and it was found to be 382.8 hours. The number of observed failures was 735 with 1181 tractors. Therefore, the failure rate was 0.0001626 per hour and the reliability for 382.8 hours was calculated to be 0.9397. The reliability of each machine is expressed if all tractors have equal reliability as follows:

$$R = e - 0.0001626 t$$

Where:

- R = unit reliability of machine
- e = base of natural logarithm
- t = time of use (h)

As the above data show, an individual machine is heterogeneous in nature. It is not realistic that a farmer has a backup unit with the same or higher reliability. It is, however, more common to retain an old unit as a backup unit in a farm. A comparison of system reliability is made in **Table 3**.

This simulation results is obtained when a farmer has a backup unit with different number of required machinery. No backup means a series system that all components perform to accomplish work. It shows that a backup machine with R = 0.5 is also able to increase its system reliability over 0.9.

#### Implication for Machinery Management

A conditional redundant system is applicable when dependent machines are operated, such as a tractor is operated to mount any unit of rotary tillers. In this case the tractor is obliged to work to perform rotary tillage.

A backup unit is able to improve system reliability but an extra cost is required to retain an extra unit. There must be a trade-off between cost for an extra unit and timeliness cost due to breakdown. This is the critical issue when a farm manager makes a decision to plan a machinery system for a particular farm.

#### Conclusion

Simulation in agriculture has grown in parallel with the popularity of systems analysis and with the demand for a more exact understanding of the real agricultural system. The importance of information in agriculture has increased as more realistic modeling is demanded. System reliability is an essential parameter to predicting system performance in simulation models for selecting machinery systems.

#### REFERENCES

- ASAE Standard EP456. 1991. Test and reliability guidelines. pp 289-294. American Society of Agricultural Engineers. St. Joseph, MI 49085.
- Barlow, R. E. and K. D. Heidtmann. 1984. Computing k-out-of-n system reliability. Ieee transaction on reliability. 33(4): 322-323.
- Hunt, D. R. 1971. Equipment reliability: Illinois and Indiana data. Transaction of ASAE. 14(4): 742-746.
- Myers, R. H., K. L. Wong, and H.M. Gordy. 1964. Reliability Engineering for Electronic Systems. John Wiley & Sons, Inc., New York.
- Shoup, W. D. 1982. Methods for predicting machinery system performance reliability. ASAE paper 82-1525.



**Table 3** Comparison of system reliability with and without backup unit

Required units for work	1	2	3
No backup	0.9397	0.8830	0.8298
1 backup with R=0.9397	0.9964	0.9895	0.9799
1 backup with R=0.5	0.9699	0.9397	0.9097

# Optimization of Size of Gasholder for Storage of Biogas in Unheated Biogas Plant

by  
Sandhya  
Assistant Professor (Agril. Engg.),  
Krishi Vigyan Kendra, Samrala  
Punjab Agricultural University,  
Ludhiana 141004, Punjab,  
INDIA  
sandhya\_1978in@yahoo.com

Parm Pal Singh  
Professor,  
School of Energy Studies for Agriculture,  
Punjab Agricultural University,  
Ludhiana-141004, Punjab,  
INDIA

## Abstract

Biogas as an energy source has many uses such as cooking, lighting and power generation. However, its main use in developing countries is domestic cooking. It is essential to provide biogas storage due to mismatch between biogas usage requirement and biogas generation rate. Regarding its use for cooking, the gas usage pattern for a typical day is repeated through out the year. At the same time biogas generation rate in an unheated biogas plant varies with season. A computer model has been developed to optimize the biogas storage size for an unheated biogas plant of given capacity using specified feedstock and situated at a given place. For biogas plants using cattle dung at Ludhiana (Punjab) the optimum energy storage ratio is 0.15 for demand ratio of 0.5. However, for all values of demand ratio between 1.0-2.0, the optimum energy storage ratio turns out to be 0.35. For optimum energy storage ratio, no biogas is released into the atmosphere for values of demand ratio from 1.0 to 2.0. However, 21.00 percent of the biogas generated gets released into atmosphere for a demand ratio of 0.5.

## Introduction

Biogas plant decomposes the waste material through an anaerobic digestion process to produce biogas and treated waste. In developed countries biogas plants are used

mainly for waste treatment. In developing countries biogas plants are being installed in villages to obtain biogas for use as an energy source and at the same time obtain decomposed manure. However, emphasis is on the use of biogas as an energy

### Nomenclature

$a_c(n)$	Auxiliary energy used in the $n^{\text{th}}$ time interval( in biogas equivalent), $m^3$
$g_a(n)$	Biogas available in the gasholder during the $n^{\text{th}}$ time interval, $m^3$
$g_c(n)$	Biogas actually consumed during the $n^{\text{th}}$ time interval, $m^3$
$g_{cr}$	Biogas consumption rate, $m^3/\text{sec}$
$g_d$	Demand of biogas per day, $m^3/\text{day}$
$g_g(m)$	Biogas generated on a typical day of $m^{\text{th}}$ month, $m^3/\text{day}$
$g_g(n)$	Biogas generated during the $n^{\text{th}}$ time interval, $m^3/\text{day}$
$g_{gr}(m)$	Biogas generation rate during $m^{\text{th}}$ month, $m^3/\text{sec}$
$g_{mr}$	Biogas in storage/gasholder in morning before the start of cooking, $m^3$
$g_r(n)$	Biogas released in the $n^{\text{th}}$ time interval, $m^3$
$g_{rnt}$	Biogas released during the night , $m^3$
$g_s(n)$	Biogas in storage/gasholder at the end of the $n^{\text{th}}$ time interval, $m^3$
$g_{sm}$	Maximum biogas storage capacity of the biogas plant, $m^3$
$g_u(n)$	Biogas used in $n^{\text{th}}$ time interval, $m^3$
$g_{ud}(m)$	Biogas consumed during the typical day of $m^{\text{th}}$ month, $m^3$
$r_c$	Rated capacity of biogas plants, $m^3/\text{day}$
$r_d$	Demand ratio
$r_g(m)$	Biogas generation ratio for a typical day of $m^{\text{th}}$ month
$r_s$	Energy storage ratio
$t(n)$	Biogas use time required during the $n^{\text{th}}$ time interval, sec
$t_{nt}$	Night time during which no biogas was used, sec
$t_t$	Total biogas use time for cooking per day, sec
$Z_{ad}$	Annual utilization factor (demand)
$Z_{ag}$	Annual utilization factor (generation)
$Z_d(m)$	Utilization factor (demand) for a typical day of $m^{\text{th}}$ month
$Z_g(m)$	Utilization factor (generation) for a typical day of $m^{\text{th}}$ month

source. The production of biogas for farm use has become an economic possibility, with the bonus of pollution control (Hobson and Feilden, 1982).

Engine performance was evaluated using simulated biogas of varying quality that represented the range of methane and carbon dioxide composition, which may be encountered in gas from different sources (Henham and Makkar, 1998). The potential use of biogas from municipal landfills to fuel urban transport busses in some Brazilian cities with large environmental benefits was studied by Kuwahara *et al.* (1999). Energy balances were analyzed from a life-cycle perspective for biogas systems based on eight different raw materials (Berglund and Borjesson, 2006). Also, fuel-cycle emissions of carbon dioxide (CO<sub>2</sub>), carbon monoxide (CO), nitrogen oxides (NO<sub>x</sub>), sulphur dioxide (SO<sub>2</sub>), hydrocarbons (HC), methane (CH<sub>4</sub>) and particles were analyzed from a life cycle perspective for different biogas systems based on six different raw materials (Borjesson and Berglund, 2006). The biogas utilization for energy production was evaluated technically and economically by Tsagarakis and Papadogiannis (2006).

The use of biogas as an energy source reduces the chance of possible emission of two greenhouse gases [methane (CH<sub>4</sub>) and carbon dioxide (CO<sub>2</sub>)] into the atmosphere at the same time. Being a renewable energy source makes its use even more attractive. Biogas as an energy source can be used in two ways: (1) for burning in a cook stove, boiler or heat generation for steam and power generation and (2) for steam-reform to obtain hydrogen for power generation in fuel cells (Komiya *et al.*, 2006).

The rate of biogas generation in a biogas plant depends on such things as the design of the biogas plant, feedstock, temperature of the feedstock in the digester and retention time of feedstock in the digester. In

a heated biogas plant, temperature of the feedstock in the digester is maintained at the desired value to allow the rate of biogas generation to be constant throughout the year. In an unheated biogas plant, the rate of biogas generation varies because the temperature of feedstock in the digester varies with ambient conditions. For a biogas plant with digester buried in the ground, the temperature in the digester follows the annual variation in soil temperature. For a biogas plant with the digester above ground, the variation in digester temperature depends on the ambient air temperature. Diurnal variation in slurry temperature is normally negligible due to the large heat capacity of the feedstock in the digester. Biogas in a given plant will be generated at a fixed rate for a heated plant and variable for an unheated plant. The rate of biogas generation is independent of the rate of biogas usage and there will always be a mismatch between the rate of biogas generation and rate of biogas usage. To overcome this problem storage of biogas is essential. For large biogas plants, separate biogas storage may be needed. Also, in such plants the feedstock in the digester is normally heated. For relatively smaller family biogas plants, storage of biogas is needed in the top portion of the digester itself. That is, the biogas storage and digester are integrated.

Biogas storage may have constant pressure or variable pressure. For constant pressure, a floating drum in the digester may be used for biogas storage. This drum moves up and down to store biogas at constant pressure. Such biogas plants are called 'KVIC Biogas Plant' in India. In KVIC biogas plants, the biogas storage space is about 50 % of the rated capacity.

The KVIC biogas system coupled with a flat plate collector was evaluated for energy production by Tiwari *et al.* (1989) and biogas plant construction technology for rural

areas was studied by Nazir Mohammad (1991). A study of the nutrients (NPK) of cattle dung (influent) and the digested cattle dung slurry (effluent) was made for a KVIC family size model (4 m<sup>3</sup>) biogas plant to evaluate nutrient recovery (Balasubramanian and Kasturi Bai, 1992). A case study of an 85 m<sup>3</sup> floating drum biogas plant installed at Palampur was found to be economically viable (Kalia and Singh, 1999).

For a variable capacity type, a fixed dome above the digester is used to store biogas. Since the volume of the fixed dome is constant, the pressure inside the fixed dome will vary with time depending on the rate of biogas generation and rate of biogas usage. Two such plant designs have been constructed in Indian villages. One design, called 'Janta Biogas Plant', has a vertical cylinder digester that requires a lot of work. The transient analysis of an improved solar assisted fixed type biogas plant has been made by Gupta *et al.* (1988). Xavier and Nand (1990) also made a preliminary study on biogas production from cow dung using fixed-bed digesters. Criteria for design of an active biogas plant have been studied by Tiwari *et al.* (1992). A long-term evaluation of a fixed dome Janta biogas plant in hilly conditions has been made by Kalia and Kanwar (1998). In another design called 'Deenbandhu Biogas Plant' the digester is egg shaped. The performance of a family size, rubber balloon biogas plant was evaluated under hilly conditions by Kanwar and Guleri (1994). Also, the performance of a 1 m<sup>3</sup> capacity modified Deenbandhu biogas plant was evaluated under hilly conditions for daily gas-production by Kanwar *et al.* (1994). The economy of different models of family size biogas plants for the state of Punjab (India) was calculated and the Deenbandhu model was found to be the cheapest and most viable model of biogas plants (Singh and Sooch, 2004).

Keeping other factors constant,

the rate of biogas generation in an unheated biogas plant depends on the season and place of installation, while the rate of biogas usage depends on the application. The optimum volume of biogas storage can be determined by coupling the rate of biogas generation with the rate of biogas usage for different times in a day and then integrating over the year. The objective of this paper is to develop methodology to determine optimum volume of biogas storage in an unheated biogas plant for a given application.

## Method

In the unheated underground biogas plants used in India, there is no diurnal variation in slurry temperature though there is seasonal variation depending primarily on the soil temperature at a given place. So, biogas generation rate on any given day is constant. Regarding the use of biogas for cooking, the gas usage pattern for a typical day is repeated through out the year while for its use for irrigation, the gas usage pattern for a typical day is repeated throughout the season (summer or winter) for a particular crop. Thus, it is essential to provide storage of biogas in a gasholder. For any given size of energy storage, there may be times when there is no biogas for use and it may be necessary to use auxiliary energy while at other times too much biogas in the gasholder may result in release of biogas in the atmosphere. Obviously, energy storage that is too large means higher cost of gasholder and energy storage that is too small results in wastage of biogas. There is a need to optimize the size of gasholder/energy storage for best results. A computer model has been developed to optimize the size of energy storage for biogas plants. The computer model has been prepared to optimize the energy storage size for unheated underground biogas

plants and it has been illustrated by calculation of results for Ludhiana (Punjab, India).

### Computer Model

The first step in the computer model is to specify the rated capacity of the biogas plant ( $r_c$ ). To generalize the results obtained from the computer model, three non-dimensional terms, namely, "Demand Ratio ( $r_d$ )", "Energy Storage Ratio ( $r_s$ )" and "Biogas Generation Ratio for a typical day of the  $m^{\text{th}}$  month [ $r_g(m)$ ]" have been defined. Values for these three terms need to be specified.

Demand ratio ( $r_d$ ) is defined as the ratio of biogas demand per day (biogas required to be used per day,  $g_d$ ) to the rated capacity of biogas plant ( $r_c$ ) as shown in **Eqn. 1**.

$$r_d = g_d / r_c \dots\dots\dots (1)$$

Energy storage ratio ( $r_s$ ) is defined as the ratio of volume of gasholder of biogas plant (maximum biogas storage capacity,  $g_{sm}$ ) to the rated capacity of biogas plant ( $r_c$ ) as shown in **Eqn. 2**.

$$r_s = g_{sm} / r_c \dots\dots\dots (2)$$

Biogas generation ratio for the  $m^{\text{th}}$  month [ $r_g(m)$ ] is defined as the ratio of biogas generation on a typical day of  $m^{\text{th}}$  month [ $g_g(m)$ ] to the rated capacity of the biogas plant ( $r_c$ ) as shown in **Eqn. 3**.

$$r_g(m) = g_g(m) / r_c \dots\dots\dots (3)$$

For a biogas plant of given rated capacity ( $r_c$ ) and for specified values of  $r_d$ ,  $r_s$  and  $r_g(m)$ , the values of biogas demand per day ( $g_d$ ), volume of gasholder (maximum biogas storage per day,  $g_{sm}$ ) and biogas generation per day for the  $m^{\text{th}}$  month [ $g_g(m)$ ] are obtained from **Eqns. 1, 2 and 3**, respectively. The day and night (24 hours) are divided into equal time intervals ( $\Delta t$ ). The biogas use time required during each of these time intervals [ $t(n)$ ] is specified for the application in hand. Then, total biogas use time during a day ( $t_i$ ) is given by summation of biogas use time during each time interval (**Eqn. 4**).

$$t_i = t(1) + t(2) + t(3) + \dots\dots + t(n) \text{ (sec)} \dots\dots\dots (4)$$

The biogas, required to be used per day (biogas demand per day), is consumed in the total time ( $t_i$ ). Thus, biogas consumption rate ( $g_{cr}$ ) is given by **Eqn. 5**.

$$g_{cr} = g_d / t_i \text{ (m}^3\text{/sec)} \dots\dots\dots (5)$$

Biogas generation continues for all the 24 hours per day. Therefore, biogas generation rate on a typical day of  $m^{\text{th}}$  month at a given place [ $g_{gr}(m)$ ] is given by **Eqn. 6**.

$$g_{gr}(m) = g_g(m) / (24 \times 60 \times 60) \text{ (m}^3\text{/sec)} \dots\dots\dots (6)$$

The next step is to determine the amount of biogas in the gasholder in the morning before biogas is used for any work ( $g_{mr}$ ). Now if the biogas consumption is less than the biogas generation on a given day then the residual biogas in the gasholder at night, when its use is stopped, will go on increasing and excess biogas in the storage will get released during the night. In this case, at the beginning of the day, biogas in the gasholder will be equal to the maximum storage capacity. On the other hand, if biogas consumption is equal or more than the biogas generation, then after a few days things will stabilize such that the residual biogas in the gasholder at night will be zero. In this case, biogas available at the beginning of the day will be equal to the biogas generated during the night. Hence, biogas in the gasholder/energy storage in morning just before the work starts ( $g_{mr}$ ) is given by **Eqn. 7a or 7b**. If the value of biogas in the gasholder in the morning ( $g_{mr}$ ), obtained from **Eqn. 7a or 7b**, turns out to be more than the capacity of the gasholder ( $g_{sm}$ ), it is set equal to the capacity of the gasholder because, in that case, extra biogas will get released into the atmosphere.

$$g_{mr} = g_{sm} \text{ for } g_{cr} < g_{gr}(m) \text{ (m}^3\text{)} \dots\dots\dots (7a)$$

$$g_{mr} = g_{gr}(m) t_{nt} \text{ for } g_{cr} \geq g_{gr}(m) \text{ (m}^3\text{)} \dots\dots\dots (7b)$$

where,  
 $t_{nt}$  = time during night when biogas is continuously shut down.

The work commences in the

morning with stored biogas. Biogas is used during the day as per the use pattern for the work for which it is to be utilized. This biogas use pattern will be determined by observations in the field conditions. The whole day is divided into equal time intervals and the gas usage time in each interval [ $t_c(n)$ ] is specified. Therefore, for each time interval, biogas required to be used [ $g_u(n)$ ] and biogas generated [ $g_g(n)$ ] is given by **Eqns. 8** and **9**, respectively.

$$g_u(n) = g_{cr} t_c(n)(m^3) \dots\dots\dots (8)$$

$$g_g(n) = g_{gr}(m) \text{delt}(m^3) \dots\dots\dots (9)$$

Therefore, the amount of biogas in the gasholder at the end of  $n^{\text{th}}$  time interval ( $g_s(n)$ ) is given by **Eqn. 10a** or **10b**.

$$g_s(n) = g_{mr} + g_g(n) - g_u(n) \text{ for } n = 1 \dots\dots\dots (10a)$$

$$g_s(n) = g_s(n-1) + g_g(n) - g_u(n) \text{ for } n > 1 \dots\dots\dots (10b)$$

Biogas available in the gasholder for use during the  $n^{\text{th}}$  time interval ( $g_a(n)$ ) is from **Eqn. 11a** or **11b**.

$$g_a(n) = g_{mr} + g_{gr}(m) \text{delt for } n = 1(m^3) \dots\dots\dots (11a)$$

$$g_a(n) = g_s(n-1) + g_{gr}(m) \text{delt for } n > 1(m^3) \dots\dots\dots (11b)$$

The auxiliary energy used in the  $n^{\text{th}}$  time interval [ $a_e(n)$ ], in terms of equivalent biogas, is given by **Eqn. 12a** or **12b**.

$$a_e(n) = 0 \text{ for } g_u(n) < g_a(n)(m^3) \dots\dots\dots (12a)$$

$$a_e(n) = g_u(n) - g_a(n) \text{ for } g_u(n) > g_a(n)(m^3) \dots\dots\dots (12b)$$

Biogas actually consumed during

$n^{\text{th}}$  time interval [ $g_c(n)$ ] is given by **Eqn. 13a** or **13b** while biogas actually consumed during the typical day of  $m^{\text{th}}$  month [ $g_{ud}(m)$ ] is given by **Eqn. 14**.

$$g_c(n) = g_u(n) \text{ for } g_u(n) < g_a(n)(m^3) \dots\dots\dots (13a)$$

$$g_c(n) = g_u(n) - a_e(n) \text{ for } g_u(n) > g_a(n)(m^3) \dots\dots\dots (13b)$$

$$g_{ud}(m) = \sum g_c(n) \text{ for } n = 1 \text{ to } n \dots\dots\dots (14)$$

If gasholder is already filled to its capacity then biogas released to the atmosphere during the  $n^{\text{th}}$  time interval [ $g_r(n)$ ] during the day is given by **Eqn. 15** while biogas released during night time ( $g_{rnt}$ ) is given by **Eqn. 16**.

$$g_r(n) = g_s(n) - g_{sm}(m^3) \dots\dots\dots (15)$$

$$g_{rnt} = g_{gr}(m) t_{nt} - g_{sm}(m^3) \dots\dots\dots (16)$$

The utilization factor-demand for a typical day of each month [ $z_d(m)$ ] and the corresponding utilization factor-generation [ $z_g(m)$ ] are given by **Eqns. 17** and **18**, respectively.

$$z_d(m) = g_{ud}(m) / g_a \dots\dots\dots (17)$$

$$z_g(m) = g_{ud}(m) / g_g(m) \dots\dots\dots (18)$$

For a typical day of each month the gas generation rate varies depending on the slurry temperature. So, the annual utilization factor-demand ( $z_{ad}$ ) is given by **Eqn. 19**, while the annual utilization factor-generation ( $z_{ag}$ ) is given by **Eqn. 20**.

$$z_{ad} = 1/12 \sum z_d(m) \text{ for } m = 1 \text{ to } 12 \dots\dots\dots (19)$$

$$z_{ag} = 1/12 \sum z_g(m) \text{ for } m = 1 \text{ to } 12 \dots\dots\dots (20)$$

Technically, the minimum value

of energy storage ratio for which  $z_{ad}$  and  $z_{ag}$  are maximum is the optimum energy storage ratio. The biogas released into the atmosphere per year as fraction of the biogas generated is equal to  $1 - z_{ad}$ .

### Biogas Usage Pattern for Cooking

A typical pattern of daily gas consumption for cooking in a household is depicted in **Fig. 1**. Gas consumption pattern remains more or less the same during the year.

## Results and Discussion

The computer models have been illustrated by optimizing the energy storage size for unheated underground biogas plants at Ludhiana using cattle dung. Typical results for biogas plants with a rated capacity of  $3 \text{ m}^3$  and demand ratio of 1.0 are given in **Table 1**. Time interval for calculations was 15 minutes. The values in the bracket are for a utilization factor-generation for the  $m^{\text{th}}$  month [ $z_g(m)$ ] and annual utilization factor-generation ( $z_{ag}$ ). From **Table 1**, it is clear that for a demand ratio of 1.0 the optimum energy storage ratio is 0.35 as it is the minimum value of energy storage ratio for which both  $z_{ad}$  and  $z_{ag}$  attain maximum value. For this value of energy storage ratio, the annual utilization factor-demand ( $z_{ad}$ ) is 0.633 indicating that 63.3 % of biogas demand

**Fig.1** Gas consumption pattern for a typical day

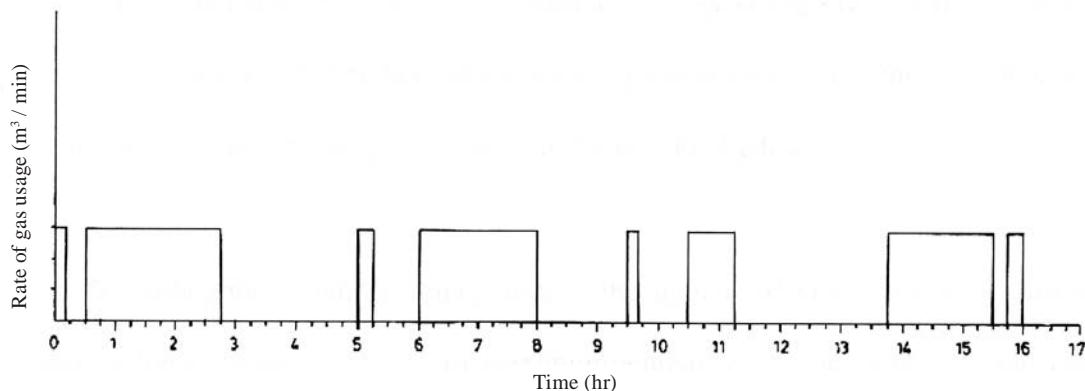

is met from biogas generated in the biogas plant and the rest from auxiliary energy. The corresponding value of annual utilization factor-generation ( $z_{ag}$ ) is 1.0 indicating that all the biogas generated is used and no biogas is released from the biogas plant into the atmosphere. Similar results were also calculated for different values of demand ratio viz. 0.5, 1.5 and 2 and these are shown in **Tables 2, 3** and **4**, respectively. Except for one case, the demand ratio is 0.5, the optimum energy storage ratio is 0.35. Both  $z_{ad}$  and  $z_{ag}$  remain constant for higher values of energy storage ratio. For the case of demand ratio of 0.5, the optimum energy storage ratio turns out to be 0.15.

Regarding the variation in magnitude of the annual utilization factor-

demand with respect to demand ratio, the value of maximum annual utilization factor-demand varies from 0.317 to 0.925 corresponding to demand ratio of 2 and 0.5. Obviously, the maximum annual utilization factor is more at lower values of demand ratio because in such cases biogas generated in the biogas plant is more than the demand for biogas. Moreover, it is necessary to use auxiliary energy for some period in a year even for a demand ratio of 0.5. This is due to variation in biogas generation and biogas use patterns.

For optimum value of energy storage ratio ( $r_s = 0.35$ ), the annual utilization factor-generation ( $z_{ag}$ ) is unity for a demand ratio of 1.0, 1.5 and 2.0, indicating that no biogas is released into the atmosphere. However, for demand ratio of 0.5, the

value of  $z_{ag}$  is 0.790, indicating that 21 percent of the biogas generated is released into the atmosphere.

It may be noted that the above results are valid for unheated underground biogas plants in northern Indian plains only. The optimum value of energy storage ratio will vary from place to place due to variation in temperature of the slurry in the biogas plant.

## Conclusions

The computer model developed in this study can be used to optimize energy storage size for a biogas plant of any capacity using any feed stock and situated at any place. For a given feed stock and design of biogas plant, the value of optimum energy storage ratio is location specific due to variation in slurry temperature. For biogas plants using cattle dung at Ludhiana the optimum energy storage ratio is 0.15 for a demand ratio of 0.5. However, for all values of demand ratio between 1.0-2.0, the optimum energy storage ratio turns out to be 0.35. It is essential to use some auxiliary energy irrespective of the value of energy storage ratio. For optimum energy storage ratio, the value of auxiliary energy used varies from 7.50 to 68.30 percent of the demand for change in demand ratio from 0.5 to 2.0. For optimum energy storage ratio, no biogas is released into the atmosphere for values of demand ratio from 1.0 to 2.0. However, 21.00 percent of the biogas generated gets released into atmosphere for demand ratio of 0.5.

## REFERENCES

- Balasubramanian, P. R., R. Kasturi Bai. 1992. Evaluation of nutrient recovery after anaerobic digestion of cattle dung in a family size biogas plant. *Biomass and Bioenergy*. 3(5): 377-380.

**Table 1** Utilization factors for biogas plant at Ludhiana with demand ratio of 1.0 (Feedstock: cattle dung and rated capacity-3 m<sup>3</sup>/day)

Energy Storage ( $r_s$ )	Utilization factor-demand for m <sup>th</sup> month [ $z_d(m)$ ]				Annual utilization Factor-demand ( $z_{ad}$ )
	m = 1, 2, 12	m = 3, 11	m = 4, 7, 8, 9, 10	m = 5, 6	
0.10	0.333 (0.953)	0.450 (0.857)	0.567 (0.810)	0.746 (0.746)	0.519 (0.843)
0.20	0.349 (1.000)	0.525 (1.000)	0.667 (0.952)	0.867 (0.867)	0.597 (0.958)
0.30	0.349 (1.000)	0.525 (1.000)	0.700 (1.000)	0.967 (0.967)	0.628 (0.995)
0.35	0.349 (1.000)	0.525 (1.000)	0.700 (1.000)	1.000 (1.000)	0.633 (1.000)
0.40	0.349 (1.000)	0.525 (1.000)	0.700 (1.000)	1.000 (1.000)	0.633 (1.000)

**Table 2** Utilization factors for biogas plant at Ludhiana with demand ratio of 0.5 (Feedstock: cattle dung and rated capacity-3 m<sup>3</sup>/day)

Energy Storage ( $r_s$ )	Utilization factor-demand for m <sup>th</sup> month [ $z_d(m)$ ]				Annual utilization Factor-demand ( $z_{ad}$ )
	m = 1, 2, 12	m = 3, 11	m = 4, 7, 8, 9, 10	m = 5, 6	
0.10	0.665 (0.953)	0.900 (0.857)	1.000 (0.714)	1.000 (0.500)	0.900 (0.762)
0.15	0.698 (1.000)	1.000 (0.952)	1.000 (0.714)	1.000 (0.500)	0.925 (0.790)
0.20	0.698 (1.000)	1.000 (0.952)	1.000 (0.714)	1.000 (0.500)	0.925 (0.790)
0.30	0.698 (1.000)	1.000 (0.952)	1.000 (0.714)	1.000 (0.500)	0.925 (0.790)
0.40	0.698 (1.000)	1.000 (0.952)	1.000 (0.714)	1.000 (0.500)	0.925 (0.790)

Berglund M. P. Borjesson. 2006. Assessment of energy performance in the life-cycle of biogas production. *Biomass and Bioenergy*. 30(3): 254-266.

Borjesson, P. and M. Berglund. 2006. Environmental system analysis of biogas systems-Part I: Fuel-cycle emissions. *Biomass and Bioenergy*. 30(5): 469-485.

Gupta, R. A., S. N. Rai, and G. N. Tiwari. 1988. An improved solar assisted biogas plant (fixed dome type): A transient analysis. *Energy Conversion and Management*. 28(1): 53-57.

Henham, A. and M. K. Makkar. 1998. Combustion of simulated biogas in a dual-fuel diesel engine. *Energy Conversion and Management*. 39(16-18): 2001-2009.

Hobson, P. N. and N. E. H. Feilden. 1982. Production and use of biogas in agriculture. *Progress in Energy and Combustion Science*. 8(2): 135-158.

Kalia, A. K. and S. S. Kanwar. 1998. Long-term evaluation of a fixed dome Janta biogas plant in hilly conditions. *Bioresource Technology*. 65(1-2): 61-63.

Kalia, A. K. and S. P. Singh. 1999. Case study of 85 m<sup>3</sup> floating drum biogas plant under hilly conditions. *Energy Conversion and Management*. 40(7): 693-702.

Kanwar, S. S. and R. L. Guleri. 1994. Performance evaluation of a family size, rubber-balloon biogas plant under hilly conditions. *Bioresource Technology*. 50: 119-121.

Kanwar, S. S., R. K. Gupta, R. L., Guleri, and S. P. Singh. 1994. Performance evaluation of a 1 m<sup>3</sup> modified, fixed dome, Deenbandhu, biogas plant under hilly conditions. *Bioresource Technology*. 51: 239-241.

Komiyama, M., T. Misonou, S. Takeuchi, Umetsu and J. Takahashi. 2006. Biogas as a reproducible energy source: Its steam reforming for electricity generation and for farm machine fuel. *International Congress Series*. 1293: 234-237.

Kuwahara, N., M. D. Berni, and S. V. Bajay. 1999. Energy supply from municipal wastes: The potential of biogas-fueled buses in Brazil. *Renewable Energy*. 16(1-4): 1000-1003.

Nazir, Mohammad. 1991. Biogas plants construction technology for rural areas. *Bioresource Technology*. 35: 283-289.

Singh, K. J. and S. S. Sooch. 2004. Comparative study of economics of different models of family size biogas plants for state of Punjab, India. *Energy Conversion and Management*. 45(9-10): 1329-1341.

Tiwari, G. N., A. Chandra, K. K. Singh, S. Sucheta, and Y. P. Yadav. 1989. Studies of KVIC biogas system coupled with flat plate collector. *Energy Conversion and Management*. 29(4): 253-257.

Tiwari, G. N., S. K. Singh, and K. Thakur. 1992. Design criteria for an active biogas plant. *Energy*. 17(10): 955-958.

Tsagarakis, K. P. and Ch. Papadogiannis. 2006. Technical and economic evaluation of the biogas utilization for energy production at Iraklio Municipality, Greece. *Energy Conversion and Management*. 47(7-8): 844-857.

Xavier, S. and K. Nand. 1990. A preliminary study on biogas production from cowdung using fixed-bed digesters. *Biological wastes*. 34: 161-165.

**Table 3** Utilization factors for biogas plant at Ludhiana with demand ratio of 1.5 (Feedstock: cattle dung and rated capacity-3 m<sup>3</sup>/day)

Energy Storage (r <sub>s</sub> )	Utilization factor-demand for m <sup>th</sup> month [z <sub>d</sub> (m)]				Annual utilization Factor-demand (z <sub>ad</sub> )
	m = 1, 2, 12	m = 3, 11	m = 4, 7, 8, 9, 10	m = 5, 6	
0.10	0.222 (0.953)	0.300 (0.857)	0.378 (0.810)	0.508 (0.763)	0.348 (0.846)
0.20	0.233 (1.000)	0.350 (1.000)	0.444 (0.952)	0.578 (0.867)	0.398 (0.958)
0.30	0.233 (1.000)	0.350 (1.000)	0.467 (1.000)	0.644 (0.967)	0.419 (0.995)
0.35	0.233 (1.000)	0.350 (1.000)	0.467 (1.000)	0.667 (1.000)	0.422 (1.000)
0.40	0.233 (1.000)	0.350 (1.000)	0.467 (1.000)	0.667 (1.000)	0.422 (1.000)

**Table 4** Utilization factors for biogas plant at Ludhiana with demand ratio of 2.0 (Feedstock: cattle dung and rated capacity-3 m<sup>3</sup>/day)

Energy Storage (r <sub>s</sub> )	Utilization factor-demand for m <sup>th</sup> month [z <sub>d</sub> (m)]				Annual utilization Factor-demand (z <sub>ad</sub> )
	m = 1, 2, 12	m = 3, 11	m = 4, 7, 8, 9, 10	m = 5, 6	
0.10	0.166 (0.953)	0.225 (0.857)	0.283 (0.810)	0.381 (0.763)	0.260 (0.846)
0.2	0.174 (1.000)	0.263 (1.000)	0.333 (0.952)	0.433 (0.867)	0.298 (0.958)
0.3	0.174 (1.000)	0.263 (1.000)	0.350 (1.000)	0.483 (0.967)	0.314 (0.995)
0.35	0.174 (1.000)	0.263 (1.000)	0.350 (1.000)	0.500 (1.000)	0.317 (1.000)
0.40	0.174 (1.000)	0.263 (1.000)	0.350 (1.000)	0.500 (1.000)	0.317 (1.000)

■ ■



# Effect of Seed Bed Preparation and Fertilization on Soil Water Storage and Barley Production Yield

by

A. Derbala

Agricultural Engineer Department  
Faculty of Agricultural,  
Tanta University  
EGYPT



N. Abd El-Kader

Soil and Water Department,  
Faculty of Agricultural,  
Tanta University  
EGYPT



T. Fouda

Agricultural Engineer Department  
Faculty of Agricultural,  
Tanta University  
EGYPT



## Abstract

Experiments were conducted out to study the effect of seed bed preparation systems and fertilizer management regimes on soil physical properties, soil water storage, water distribution efficiency and barley yield. The experimental soil was classified as compacted heavy clay. Barley (v. Giza 123) was planted and surface irrigation was used. Three seed bed preparation systems were used: (1) chisel plough (twice) and land leveler; (2) chisel plough (one pass) followed by rotary plough and land leveler and (3) no tillage with land leveler as a control. Three fertilizers management applications were used: (1) mineral fertilizer with 100 % N; (2) organic fertilizer with 100 % N; and (3) mixed 50 % N mineral and 50 % N organic fertilizers. The results revealed that the one pass chisel plough followed by rotary plough and land leveler, along with manure, organic fertilization was the proper system for

soil water storage and for producing the barley crop. The maximum reduction in bulk density was 15.97 %, the maximum increase in soil porosity was 53.2 %, the maximum increase in accumulative infiltration rate was 6.28 cm and the maximum value of soil water storage and water distribution efficiency was 392.45 m<sup>3</sup> fed<sup>-1</sup> and 57.35 %, respectively. Finally, the maximum barley yield was 1.86 ton/fed\* with minimum cost of 58.94 L.E/ton.

## INTRODUCTION

Water stored in the soil is of great importance for increasing and stabilizing yields. This can be achieved by an adequate selection of tillage systems and fertilizer management regimes that, increase the water availability for the crop by increasing soil infiltration and allowing a better development of root system depending on soil conditions.

Lal (1999) studied the effects of

three tillage methods on the physical properties of a clayey soil. Tillage treatments included no-till (NT), chisel plowing (CP) and moldboard plowing (MP). There was a significant effect on soil bulk density ( $\bar{A}b$ ). The mean soil bulk density was 1.34 Mgm<sup>-3</sup> for 0 to 10 cm depth and 1.39 Mgm<sup>-3</sup> for 10 to 20 cm depth. Although not significantly different, trends in soil bulk density were NT > MP > CP for 0 to 10 cm depth and NT > MP > CP for 10 to 20 cm depth. Hydraulic conductivity (Ks) was highly variable and treatments had no effect. Moisture retention characteristics differed significantly among depths but not among treatments.

Phosphate, fertilizer application resulted in a small increase in water use (7-14 %). Increased barley yield due to the application of fertilizer was accompanied by an increase in the water use efficiency (WUE).

\*One feddan (fed.) represents an agricultural area unit in Egypt = 4200.83 m<sup>2</sup>

The beneficial effect of fertilizers could be attributed to the rapid early growth of leaves which contributed to reduction of soil evaporative losses and increased WUE. The average increase in the WUE due to the addition of fertilizer was 84 %.

Jerry *et al.* (2001) stated that a survey of literature revealed a large variation in measured WUE across a range of climates, crops and soil management practices. It was possible to increase WUE by 25 to 40 % through soil management practices that involved tillage. Overall, precipitation use efficiency could be enhanced through adoption of more intensive cropping systems in semi-arid environments and increased plant populations in more temperate and humid environments. Modifying nutrient management practices could increase WUE by 15 to 25 %. Water use efficiency could be increased through proper management and field scale experiences showed that these changes positively affected crop yield.

Ardell *et al.* (2002) stated that on the average spring soil NO<sub>3</sub>-N (0 to 120 cm depth) levels in the conservation tillage CT, minimum tillage MT and no tillage NT plots were 144, 136 and 117 kg N ha<sup>-1</sup>, respectively.

Morad and Fouda (2003) studied the total energy required to produce one ton of flax under different treatments. Energy values were arranged in descending order. Chiseling twice, rotary plow, land leveler, manual planting and mechanical harvesting by pulling the machine required the highest value of energy (23.64 kWh/ton). Chiseling twice, rotary plow, land leveler, mechanical planting by seed drill and manual harvesting required the lowest value of energy (16.10 kWh/

ton). They showed that seed yield values were 550, 570 and 620 kg/fed while straw yield values were 2.64, 2.73 and 3.20 ton/fed under manual, broadcasting and seed drill, respectively.

El-Tarhony and Fouda (2005) compared the following tillage systems: Conventional tillage with a moldboard plough with disc harrow and rotary cultivator (T<sub>1</sub>), reduced tillage with a rotary cultivator (T<sub>2</sub>), disc harrow (T<sub>3</sub>), chisel plough (T<sub>4</sub>) and no tillage (T<sub>5</sub>) as a control. With the use of tillage systems T<sub>1</sub>, T<sub>2</sub>, T<sub>3</sub> and T<sub>4</sub> the fuel consumption was 27.70, 6.21, 11.20 and 10.10 L/ha and energy values were 81.25, 16.70, 30.70 and 28.40 kWh/ha. The sorghum yield values were 2.9, 3.1, 2.3, 2.6 and 1.9 kg.m<sup>-2</sup> under treatments T<sub>1</sub>, T<sub>2</sub>, T<sub>3</sub>, T<sub>4</sub> and T<sub>5</sub>, respectively.

Chiroma *et al.* (2006) concluded that combining the practice of flat bed cultivation with mulching might eliminate the need of ridging for increased productivity. A four year field experiment was conducted to evaluate the influence of land configuration practices with or without wood-shavings mulch on water conservation, yield and water use efficiency. Differences in soil water storage at various sampling dates were significant only in some cases in each year, but trends were towards greater soil water storage in the mulched treatments than in the non-mulched treatments, irrespective of tillage method. Growth parameters such as plant height and leaf area index indicated significant differences between treatments only for some measurement dates in each year.

Cantero-Martinez *et al.* (2007) compared different tillage systems established at three locations according to their degree of aridity.

Conservation tillage was most effective in increasing yield under the driest conditions at A<sub>1</sub> (10-15 %), less effective with a smaller advantage under slightly wetted conditions at A<sub>2</sub> (5-10 %) but ineffective at A<sub>3</sub>, the wettest site. Conservation tillage only increased water use in some years at A<sub>1</sub> and never at the other two sites.

The objective of this work was to select a suitable seed bed preparation system with optimum fertilizer management to increase both water use efficiency and soil water storage for maximum crop yield and to minimize energy requirements and cost of production.

## Materials and Methods

This research was conducted at the Faculty of Agriculture Farm, Tanta University, El-Gharbia Governorate, Egypt. The experiments were initiated on Jan 2007 and were designed to select a suitable seed bed preparation system and fertilizer management for barley crop (*Hordeum vulgare* L.) v. Giza 123. The experimental soil was classified as a compacted heavy clay soil as shown in **Table 1**. Parameters measured throughout the farm included the real density which was 2.63 gcm<sup>-3</sup>.

### Machine Specification

The technical specifications of the experimental equipment were:

A Russian made 66.18 kW 2200 r.p.m four cylinder, four stroke diesel, Belarus-MTZ-90 tractor that had a hydraulic system, was water cooled and had four wheels.

A locally made, mounted chisel plough with nine tines, a work-

**Table 1** Mechanical analysis and physical properties of the experimental soil

Particle size distribution, %			Texture	Bulk density, gcm <sup>-3</sup>	Field capacity, %	pH	EC dsm <sup>-1</sup>	OM, %
Clay	Silt	Sand						
44	40	16	Clay	1.44	31.00	7.14	4.02	1.50

ing width of 225 cm and overall dimensions of 1650 × 2000 × 1050 mm.

Mounted rotary plough (ADH 114 locally made) with 32 blades corresponding to 160 cm working width.

Trailling land leveler (locally made) with 3.05 m working width.

Mounted broadcasting machine (locally made), 120 cm long, and a 50 cm spinner diameter with 15 m working width.

A locally made rear discharge fertilizer spreader with overall dimensions of 400 × 200 × 115 cm and load capacity 3.5 m<sup>3</sup>.

Plowing depth was generally 10-12 cm at a speed of 3.5 km/h while harrowing and leveling were conducted at a speed of 4.8 km/h.

## Experiments

The experimental area was about 3 feddans divided into three equal plots (1 feddan each). The 9 treatments: A, B, C, D, E, F, G, H and I were conducted on each plot and replicated three times in a completely randomized block design.

Treatment A: seed bed preparation system by chisel plough (twice) and then land leveler with mineral fertilizing (100 % N) at the recommended dose by broadcasting spreader.

Treatment B: seed bed preparation system by chisel plough (one pass) with rotary plough and then land leveler with mineral fertilizing (100 % N) at the recommended dose by broadcasting spreader.

Treatment C: no tillage with land leveler and mineral fertilizing (100 % N) at the recommended dose by broadcasting spreader.

Treatment D: seed bed preparation system by chisel plough (twice) and then land leveler with organic fertilizing (100 % N) by manure fertilizer spreader.

Treatment E: seed bed preparation system by chisel plough (one pass) with rotary plough and then land

leveler with organic fertilizing (100 % N) by manure fertilizer spreader.

Treatment F: no tillage with land leveler and organic fertilizing (100 % N) by manure fertilizer spreader.

Treatment G: seed bed preparation system by chisel plough (twice) and then land leveler with mixed mineral and organic fertilizing (50 % N mineral with 50 % N organic) by manure fertilizer spreader.

Treatment H: seed bed preparation system by chisel plough (one pass) with rotary plough and then land leveler with mixed mineral and organic fertilizing (50 % N mineral with 50 % N organic) by manure fertilizer spreader.

Treatment I: no tillage then land leveler with mixed mineral and organic fertilizing (50 % N mineral with 50 % N organic) by manure fertilizer spreader.

## Fertilizer Management

Fertilizers were added to the soil mechanically using the broadcasting machine for mineral fertilizer (F<sub>1</sub>), manure fertilizer spreader for both organic (F<sub>2</sub>) and the mixture fertilizer (F<sub>3</sub>).

The recommended amounts of nitrogen and super phosphate were added as follows:

F<sub>1</sub>: mineral (100% N) from nitrogen (52.49 kg N/fed.) with phosphorus (6.758 kg P/fed.),

F<sub>2</sub>: organic (100 % N) from farm yard manure (0.9 % N) and

F<sub>3</sub>: mixed mineral and organic 50 % F<sub>1</sub> with 50 % F<sub>2</sub>.

Phosphorus doses as calcium super phosphate (15.5 %), organic fertilizer (F<sub>2</sub>) and 50 % organic fertilizer (F<sub>3</sub>) were dressed once only directly before cultivation of barley. Nitrogen doses as ammonium nitrate NH<sub>4</sub>NO<sub>3</sub> (34.997 % N) (F<sub>1</sub>) and 50 % mineral fertilizer (F<sub>3</sub>) were divided in three doses; the first active dose was 20 % of the recommended nitrogen amount before cultivation, the second dose was 40 % after 50 days from sowing and the third was 40 % added after 70

days from sowing. Mineral fertilizing speed was about 3.2 km/h while both organic and the mixture fertilizing speed were 2.8 km/h.

## Planting Methods

Barley was planted mechanically using the broadcasting machine with a seed rate of 50 kg/fed. and a planting speed of about 3.2 kmh<sup>-1</sup>.

## Irrigation System

The surface irrigation system was used with an applied irrigation depth of 100 mm/irrigation for all treatments. This applied water was measured by flow tube and time recorded by stopwatch. Soil samples were collected for each tillage and fertilizer treatment before and 48 h after irrigation at a soil depth from 0 to 40 cm. Also, soil samples were taken between the first and the second irrigation in the same way.

## Soil measurements

**Bulk density:** Soil bulk density was measured by the core method (Blake and Hartge, 1986).

**Soil porosity:** The soil porosity was measured before and after each operation and was calculated using the following formula:

$$S_p = (1 - D_b/D_p) \times 100$$

Where:

S<sub>p</sub> = soil porosity in percent,  
D<sub>b</sub> = bulk density in gcm<sup>-3</sup> and  
D<sub>p</sub> = particle density in gcm<sup>-3</sup>.

**Infiltration rate:** Infiltration rate was determined using double ring at three different sites along the furrow in three replicates for each treatment and it was measured for three hours until a steady state was reached according to (Cuenca, 1989).

## Water Measurements

**Application Efficiency:** Application efficiency (E<sub>a</sub>) was calculated at each treatment according to (Israelson and Hansen, 1962) as follows:

$$E_a = (w_s / w_f) \times 100$$

Where:

E<sub>a</sub> = irrigation application ef-

iciency in percent,  
 $w_s$  = stored water within irrigation in mm and  
 $w_f$  = depth of water diverted to the area irrigated in mm.

**Water Distribution Efficiency:** This was calculated according to James (1988) as follows:

$$E_d = (1 - s/d) \times 100$$

Where:

$E_d$  = water distribution efficiency in percent,  
 $s$  = average numerical deviation from "d" in cm and  
 $d$  = average of soil water depth stored along the furrow.

**Water Use Efficiency:** This was determined according to Awady *et al.* (1976) as follows:

$$\text{WUE (kgm}^{-3}\text{)} = \text{Average yield (kg ha}^{-1}\text{)} / \text{Amount of applied water m}^3\text{/ha.}$$

**Soil Water Storage:** Soil water storage was determined as an amount of applied water in one irrigation in proportion to wetted area and wetted depth of soil.

**Harvesting Method:** Manual harvesting: using the conventional method.

### Yield Measurements

The harvesting was done on 23/5/07 (about 130 days). At maturity of plants, one meter square was taken from all treatments to measure the length of plant, biomass yield (grain yield  $\text{kgm}^{-2}$ , straw yield  $\text{kgm}^{-2}$ ) and the following traits, (1) 1,000 grain weight (g), (2) total

yield ( $\text{kgm}^{-2}$ ) and (3) harvesting index (grain yield/total yield).

### Energy Requirements

Energy requirements were calculated by using the following eqn.:

Energy requirements ( $\text{kWh/fed.}$ ) = Power required (kW) / Effective field capacity ( $\text{fed./h.}$ ). Estimation of the required power to operate each machine was carried out by accurately measuring the decrease in fuel level in the fuel tank immediately after executing each operation. The required power was calculated according to Barger *et al.* (1963) as follows:

$$P \text{ (kW)} = w_f \times \text{c.v.} \times \eta_{th} \times (427 / 75) \times (1 / 1.36)$$

Where:

$w_f$  = rate of fuel consumption in kg/sec,

c.v. = calorific value of fuel in kcal/kg, (average c.v. of solar fuel was 10,000 kcal/kg) 427-thermo-mechanical equivalent,  $\text{kgm/kcal.}$

$\eta_{th}$  = thermal efficiency of the engine was considered to be 30 % for diesel engines.

### Cost Analysis

The cost of mechanical processes was determined according to Awady (1978) as follows:

$$C = \frac{P}{h} \left( \frac{I}{e} + \frac{i}{2} + t + r \right) + (0.9hp \times f \times s) + \frac{w}{144}$$

Where: c = hourly cost, P = capi-

tal investment, h = yearly operating hours, e = life expectancy, i = interest rate, t = taxes and over head ratio, r = repairs ratio of the total investment, 0.9 was a factor including reasonable estimation of the oil consumption in addition to fuel, hp = horse power of engine and f = specific fuel consumption, L/hph.

The operational cost can be calculated as follows:

$$\text{Operational cost (L.E./fed)} = \text{hourly cost (L.E./fed)} / \text{effective field capacity (fed/h)}$$

$$\text{Cost per unit of production (L.E./ton)} = \text{operational cost (L.E./fed)} / \text{crop yield (ton/fed)}$$

## Results and Discussion

### Effect of Seed Bed Preparation System and Fertilizer Management on Some Soil Physical Properties

Soil physical properties were determined before and after each treatment. The results in **Table 2** show that there are differences in the soil bulk density, soil porosity, air filled porosity and accumulative infiltration rate using different seed bed preparation systems and fertilizer management.

Bulk density generally decreased due to tillage. The maximum reduction in bulk density of 15.97 % was observed under treatment D (chisel plough twice and land leveler with organic fertilizer distributed by manure fertilizing machine). This

**Table 2** Effect of seed bed preparation system and fertilizer management on soil physical properties

Fertilizer Treatment	Soil before tillage	Mineral fertilizer by broadcasting machine			Organic fertilizer by manure fertilizing machine			Mixed fertilizer by broadcasting machine		
		A	B	C	D	E	F	G	H	I
Bulk density, $\text{gcm}^{-3}$	1.44	1.41	1.40	1.43	1.21	1.23	1.33	1.25	1.30	1.35
Soil porosity, %	45.0	46.4	46.8	45.6	53.1	53.2	49.0	52.5	50.6	48.0
Accumulative infiltration rate, cm	1.98	2.16	5.20	2.16	3.42	6.28	2.70	3.10	5.92	2.50

A, D and G used chisel plough (twice) and land leveler  
 B, E and H chisel followed by rotary plough and land leveler  
 C, F and I no tillage with land leveler

was explained by the fact that the density decreased distributed by increasing tillage procedures involved in the treatment. Also, the same effect was obtained with treatment D that treated organic fertilizer 100 % (confirmed by Ghuman and Sur, 2001).

**Table 2** showed that the maximum value in the soil porosity was 53.2 % under treatment E, while the minimum value was 45.60 % under treatment C. These results were confirmed with the obtained data of bulk density.

The accumulative infiltration rate was affected by the changes that occur due to physical characteristics caused by tillage practices and fertilizer management. The maximum value of accumulative infiltration rate was 6.28 cm under treatment E, while the minimum value was 2.16

cm under treatment C. The accumulative infiltration rate was inversely related to the bulk density values in various treatments (confirmed by Ghuman and Sur, 2001).

#### Effect of Seed Bed Preparation System and Fertilizer Management on Water Measurements

The values of water application efficiency and water distribution efficiency are shown in **Fig. 1**. The maximum values of the application efficiency and the distribution efficiency were 76.72 % and 57.35 % respectively, under treatment E. The minimum values were 52.09 % and 49.90 % respectively, under treatment C. Treatment E developed water application efficiency compared with the others because the amount of water stored in the root zone was increased. These results were con-

firmed with the decrease of bulk density and increase of total porosity and accumulative infiltration rate. Also, treatment E developed a water distribution efficiency compared with the others because the soil under treatment E (chisel followed by rotary plough and land leveler) was not compacted.

The values of the water use efficiency and the amount of water storage are shown in **Figs. 2 and 3**. The highest value of water use efficiency meant that less irrigation water was required for high crop yield. The maximum values of the water use efficiency and soil water storage were 2.22 kgm<sup>-3</sup> and 392.45 m<sup>3</sup>fed<sup>-1</sup> respectively under treatment E. And the minimum values were 1.07 kgm<sup>-3</sup> and 185.56 m<sup>3</sup>fed<sup>-1</sup> respectively under treatment C because adding manure to the soil tended to

**Fig. 1** Effect of seed bed preparation system and fertilizer management on the application efficiency and the distribution efficiency

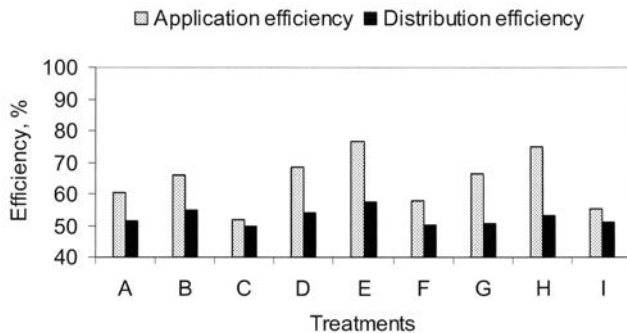

**Fig. 2** Effect of seed bed preparation systems and fertilizer management on water use efficiency

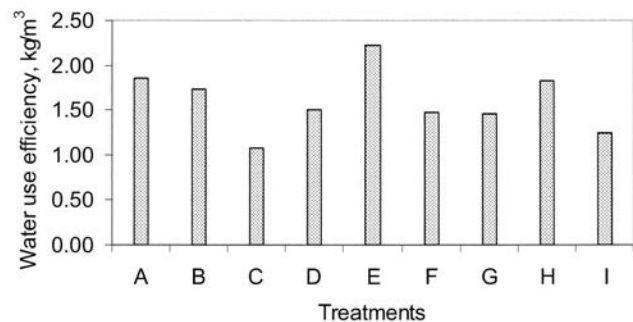

**Fig. 3** Effect of seed bed preparation systems and fertilizer management on the amount of soil water storage

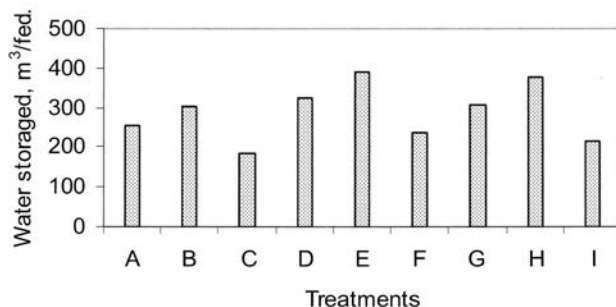

increase both storage of water, total porosity, accumulative infiltration rate and decreased bulk density (Table 2). On the other hand, no tillage treatment increased the losses of water, then decreased in the soil water stored.

### Effect of Seed Bed Preparation System and Fertilizer Management on Plant Characteristics and Crop Yield

Tillage systems and fertilizer management had a great effect on the plant features such as length of plant, weight of 1000 grains, the average biological yield and harvest index. It was observed in Table 3 that the maximum plant length of 98.50 cm was identified under treatment H. It decreased to 75.50 cm under treatment C. Also, the data showed that the maximum weight of 1000 grains was 51.40 g under treatment E and decreased to a minimum of 29.20 g under treatment C. Table 3 also showed that the maximum biological yield and harvest index were found under treatment E.

These results were confirmed with the bulk density, total porosity, air field capacity, water application efficiency, water distribution efficiency and water use efficiency. The data confirmed those obtained by Ghuman and Sur (2001). It was evident from these results that treatment E was an alternative and sustainable practice of soil management while it also improved soil properties (Table 2).

### Energy Requirements for Barley Production

Table 4 shows the fuel consumption and power required for each machine. Fig. 4 shows the effect of seed bed preparation systems and fertilizer management on energy requirements. Values can be arranged in descending order as follows: I, F, E, H, B, G, D and A, respectively. It is clear that treatment A, using the chisel plough (twice) and land leveler with fertilizing by broadcasting machine, required the highest value of energy (48.18 kWh/ton). Treatment I required the lowest value of

energy (17.25 kWh/ton).

### Cost Requirements for Barley Production

Fig. 5 represents the cost per unit of production for the different treatments. The cost per unit of production can be arranged in descending order as follows: E, F, I, H, B, C, G, D and A, respectively. Treatment E recorded the lowest value of cost per unit of production; 58.94 L.E/ton.

### Conclusions

The seeds bed preparation system by chisel plough, one pass with rotary plough and with land leveler is recommended for producing barely crop since it records the maximum yield and minimum cost compared with the other treatments. Organic fertilization by manure fertilizing machine is recommended as it improves soil physical properties and increases soil water storage.

**Table 3** Effect of seed bed preparation systems and fertilizer management on plant characteristics and crop yield

Fertilizer	Mineral fertilizer by broadcasting machine			Organic fertilizer by manure fertilizing machine			Mixed fertilizer by broadcasting machine		
	A	B	C	D	E	F	G	H	I
Length of plant, cm	81.25	86.00	75.50	95.00	96.51	88.25	89.50	98.50	82.00
Weight of 1,000 grain, g	48.60	44.70	29.20	48.90	51.40	41.40	45.20	48.60	36.50
Biological yield, ton/fed	0.900	1.457	0.722	1.275	1.866	0.995	1.218	1.531	0.952
Harvest index, %	0.34	0.35	0.24	0.33	0.39	0.27	0.28	0.30	0.26

A, D and G used chisel plough (twice) and land leveler

B, E and H chisel followed by rotary plough and land leveler

C, F and I no tillage with land leveler

**Table 4** Fuel consumption, power and energy requirements for the used equipment

Fertilizer	Fuel consumption, L/fed	Power required, kW	Field capacity, fed/h	Energy requirements, kWh/fed
Chisel plough 1 <sup>st</sup>	6.20	19.84	1.40	14.17
Chisel plough 2 <sup>st</sup>	5.75	18.40	1.44	12.77
Rotary plough	6.30	20.16	2.61	7.75
Land leveler	2.90	9.28	1.37	6.77
Broad casting	3.20	10.24	1.06	9.66
Manure fertilizing machine	15.20	48.64	3.20	15.20

## REFERENCES

- Ardell, D., L. Alfred, M. Joseph, D. Steven, J. Brian, and L. Donald. 2002. Spring wheat response to tillage system and nitrogen fertilization within a crop-fallow system. *American Society of Agronomy, Agronomy Journal*, 92: 288-294
- Awady, M. N. 1978. Tractor and farm machinery. Text book, Col. Agr. Ain-Shams Uni.: 164-167.
- Barger, E. L., J. B. Liljedahl, W. M. Carleton, and E. G. Mckibben. 1963. Tractor and their power units. 2nd ed. John Wiley and Sons, Inc., New York, U.S.A.
- Blake, G. R. and K. H. Hartge. 1986. Bulk density. In: Klute, A. (ed.), *Methods of soil analysis. Part 1. Agronomy 9. ASA, Madison, WI*, pp. 363-375.
- Cantero-Martinez, C., P. Angas, and J. Lampurlanes. 2007. Long-term yield and water use efficiency under various tillage systems in Mediterranean rainfed conditions. *Annals of Applied Biology*. 150 (3): 293-305.
- Chiroma, A. M., A. Folorunso, and A. B. Alhassan. 2006. Soil water conservation, growth, yield and water use efficiency of sorghum as affected by land configuration and wood-shavings mulch in semi-arid northeast Nigeria. *The Journal of Agricultural Science, Cambridge journals online*. 42: 199-216.
- El-Tarhuny, M., T. Fouda, and A. Billaid. 2005. Effect of reduced tillage systems on sorghum yield under soil Libyan conditions. The 13th annual conference of the Misr J. of Ag. Eng., 22(4) :610-623.
- Ghuman, B. S. and H. S. Sur. 2001. Tillage and residue management effects on soil properties and yields of rainfed maize and wheat in a subhumid subtropical climate. *Soil and tillage*. 58: 1-10.
- Israelsen, O. W. and V. E. Hansen. 1962. *Irrigation principles and practices*, 3rd ed. John Willey and Sons, New York, USA.
- James, L. G. (1988): *Principles of farm irrigation system design*. John Willey and Sons (ed.), New York, USA pp. 543.
- Jerry, L. H., J. S. Thomas, and H. P. John. 2001. Managing soils to achieve greater water use efficiency. *American Society of Agronomy, Agronomy Journal*. 93: 271-280.
- Lal, R. 1999. Soil compaction and tillage effects on soil physical properties of a mollic ochraqualf in northwest Ohio. *School of Natural Resources, the Ohio State University, Columbus*. 14: 53-65.
- Morad, M. and T. Fouda. 2003. Selection of optimum mechanization system for flax production. *Misr J. of Ag. Eng.. 20(3): 879-890*.
- Sivakumar, M. V. K. and S. A. Sa-laam. 1999. Effect of year and fertilizer on water use efficiency of pearl millet (*pennisetum glaucum*) in Niger. *The Journal of Agricultural Science, Cambridge journals online*. 132: 139-148. ■■

**Fig. 4** Effect of seed bed preparation systems and fertilizer management on energy requirements

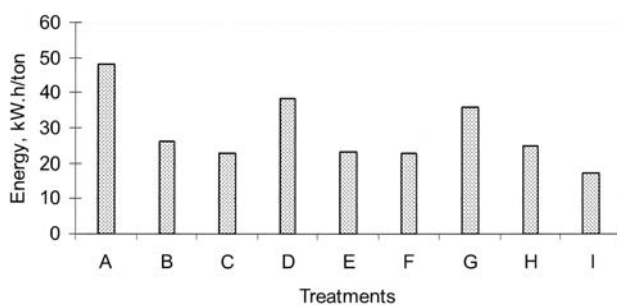

**Fig. 5** Effect of seed bed preparation systems and fertilizer management on cost per unit of production

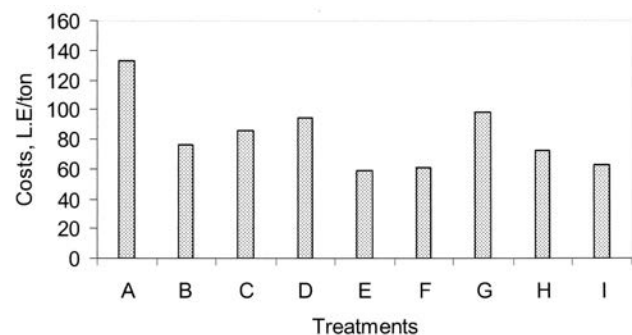

829

**Weeding in Arid Region - State of the Art and Development of Improved Manual Weeders: Harpal Singh**, Principal Scientist & Head, **H. L. KUSHWAHA**, Scientist Sr. Scale (FM & P), **Anil K. Singh**, Sr. Scientist (FM & P), **Shailendra Kale**, Technical Assistant, **T. K. Bhati**, Principal Scientist (Agronomy), **Amit Singh**, Technical Assistant, Division of Agril. Engineering and Energy, Central Arid Zone Research Institute (CAZRI), Jodhpur-342003, Rajasthan, India

Weeding is an important farm activity largely performed by farm women. In arid region of western Rajasthan, manually operated Kassi is being used as weeder. It involves drudgery of women as it, on an average, requires 83.4 N pull under prevailing sandy soils conditions. The existing kassi was modified by providing slots on its blind face and performance evaluation of five weeding tools, namely, traditional Kassi modified Swiss hoe, single slot Kassi, double slot Kassi and wheel hoe was carried out in respect of field capacity, pull requirement, weeding index and field performance. Double slot Kassi, in general, may find higher acceptability over other tools amongst the arid zone farmers due to its low pull requirement (53.9 N) and high field capacity (193.4 m<sup>2</sup>h<sup>-1</sup>). The pull requirement of single slot Kassi was lowest (34.3 N) and is suitable for use by the farm women.

831

**Effects of Tillage Methods and Sowing Rates on the Grain Yields and Yield Components of Rain Fed Wheat: H.T Shamsabadi**, Department of Farm Machinery, **A. Biabani**, Department of Agricultural Sciences, University of Agricultural Sciences & Natural Resources, Gorgan, Iran; **Desa Ahmad**, Department of Biological and Agricultural Engineering, University, Putra Malaysia (UPM), Serdang, Selangor, Malaysia

A field study was investigated on the effect of four primary tillage implements and three seed densities on the grain yield of rain fed wheat (Tajan cultivar), using a special drill planting machine. The experimental design was a split plot design in a 4 × 3 factorial with three replications. In this study, main plots were tillage treatments namely Moldboard plow (MP), Disk Plow (DP), Chisel Plow (CP), Offset Disk (OD); and sub plots were seed rates of 350, 400, 450 seed/m<sup>2</sup>. Determinations included grain yield of rain fed wheat and some yield components. Results show that grain yield was not affected by seed density and tillage machine treatments. Nevertheless Chisel Plow has been proposed as a promising tool to improve the soil physical, chemical and biological properties; soil erosion, moisture control, energy usage timeliness and cost of production. The use of Chisel Plow with 400 seed/m<sup>2</sup> sowing rate was recommended to

increase the grain yield of wheat grown in the Golestan province (Iran), a region with an average annual rainfall of 450mm.

839

**Studies on Osmotic Dehydration of Carrot (Daucus carota L.): Dawn. C. P. Ambrose**, Senior Scientist, Central Institute of Agricultural Engineering-IEP Centre; **V.Thirupathi**, Associate Professor, Department of Food & Agricultural Process Engineering; **CT. Devadas**, Former Dean, Agricultural Engineering College & Research Institute, Tamil Nadu Agricultural University, Coimbatore-641 003, India.

Carrot (*Daucus carota L.*) is a root crop rich in  $\beta$ -carotene. Osmotic dehydration is a low energy requiring method which could be adapted to process carrots during their glut season. Sucrose, sodium chloride at various concentrations and also their combinations were used as osmotic agents. Sucrose 65 % + NaCl 10 % combination yielded to maximum water loss in carrots. The osmosed samples were further dried under vacuum, fluidized bed and tray drying at 70 °C. The osmo-vac sampled resulted in higher rehydration ratio and  $\beta$ -carotene compared to other air dried samples.

840

**Performance Evaluation of Laboratory Model Abrasive Polisher for Production of White Pepper from Black Pepper: V.Thirupathi**, Associate Professor; **R. Viswanathan**, Professor and Head, Department of Food & Agricultural Process Engineering, Agricultural Engineering College and Research Institute, Tamil Nadu Agricultural University, Coimbatore - 03.

White pepper is prepared is also prepared by removing black skin of dried black pepper. In a laboratory scale study, an abrasive type polisher was used for removing the outer black skin of the dried black pepper. The laboratory model abrasion polisher consists of an abrasive stone mounted on a rotor shaft. Along the periphery of the abrasive stone it is covered by perforated screen, with 2 mm diameter perforation. Separate outlets are provided for collecting the skin and polished pepper. The unit was evaluated at different peripheral speed of abrasive stone (170, 226 and 280 m/min), different levels of clearance (6, 9 and 12 mm) for various commercial grades of abrasive stone (A 24, A 60 and A 46 grades). The samples were steamed, boiled and untreated before polishing. Maximum polishing efficiency of 92.9 percent and maximum recovery (65.7%) of white pepper from black pepper were achieved at 283 m/min peripheral speed and 9 mm clearance by using A46 grade stone for steamed pepper. Broken (9.4%) was minimum at 170 m/min and 12 mm clearance on A24 and A46 grade stones for both boiled and steamed samples. ■■



# Co-operating Editors



B Kayombo



M F Fonteh



A A K  
El Behery



A M  
El Hossary



B S Pathak



R J Bani



I K Djokoto



D K Some



K Hourmy



J C Igbeka



E U-Odigboh



K C Oni



L U Opara



N G  
Kuyembah



A H  
Abdoun



A B Saeed



A I Khatibu



E A Baryeh



S Tembo



H A  
Cetrangolo

## -AFRICA-

### Benedict Kayombo

Associate Professor of Soil and Water Engineering, Dept. of Agric. Engineering and Land Planning, Botswana College of Agriculture, University of Botswana, Private Bag 0027, Gaborone, BOTSWANA. TEL+(267)-3650125, FAX+(267)-328753 E-mail: bkayombo@bca.bw

### Mathias Fru Fonteh

Asst. Professor and Head, Dept. of Agric. Engineering, Faculty of Agriculture, University of Dschang, P.O. Box 447, Dschang, West Province, CAMEROON TEL+237-45-1701/1994, FAX+237-45-2173/1932 E-mail: m.f.fonteh@camnet.cm

### Ahmed Abdel Khalek El Behery

Agric Engineering Research Institute, Agricultural Reserch Center, Nadi El-Said St. P.O. Box 256, Dokki 12311, Giza, EGYPT

### Ali Mahmoud El Hossary

Senior Advisor to the Ministry of Agriculture and Chairman of (AGES)-Agengineering Consulting Group, Ministry of Agriculture - P.O.Box 195 Zama-lek 11211 Cairo, EGYPT TEL00-202-335-9304, FAX00-202-3494-132

### B. S. Pathak

Project Manager, Agric. Implements Research and Improvement Centre, Melkassa, ETHIOPIA

### Richard Jinks Bani

Lecturer & Co-ordinator, Agric. Engineering Div., Faculty of Agriculture, University of Ghana, Legon, GHANA

### Israel Kofi Djokoto

Senior Lecturer, University of Science and Technol-ogy, Kumasi, GHANA

### David Kimutaiarap Some

Professor, Deputy Vice-chancellor. Moi University, P.O. Box: 2405, Eldoret, KENYA

### Karim Houmy

Professor and head of the Farm Mechanization Dept., Institute of Agronomy and Velerinary Medi-cine II, Secteur 13 Immeuble 2 Hay Riad, Rabat, MOROCCO, Tel+212-7-68-05-12, Fax+212-7-775801 E-mail: houmy@maghrebnet.net.ma

### Joseph Chukwugotium Igbeka

Professor, Dept. of Agricultural Engineering, Univ. of Ibadan,, Ibadan, NIGERIA TEL+234-2-8101100-4, FAX+234-281030118 E-mail: Library@ibadan.ac.ng

### E. U. Odigboh

Professor, Agricultural Engg Dept., Faculty of En-gineering, University of Nigeria, Nsukka, Enugu state, NIGERIA, TEL+234-042-771676, FAX042-770644/771550, E-mail: MISUNN@aol.com

### Kayode C. Oni

Director/Chief Executive, National Centre for Agric. Mechanization (NCAM), P.M.B.1525, Ilorin, Kwara State, NIGERIA TEL+234-031-224831, FAX+234-031-226257 E-mail: ncam@skannet.com

### Linus U. Opara

Research Professor, S. Africa Chair in Postharvest Technology, Faculty of AgriSciences, Stellenbosch University, Private Bag X1, Stellenbosch 7602, SOUTH AFRICA TEL+27-21-808-4604, FAX+27-21-808-2121, E-mail: opara@sun.ac.za

### N. G. Kuyembah

Associate Professor, Njala University Colle, Univer-sity of Sierra Leone, Private Mail Bag, Free Town, SIERRA LEONE TEL+249-778620-780045, FAX+249-11-771779

### Abdien Hassan Abdoun

Member of Board, Amin Enterprises Ltd., P.O. Box 1333, Khartoum, SUDAN

### Amir Bakheit Saeed

Assoc. Professor, Dept. of Agric. Engineering, Fac-ulty of Agriculture, University of Khartoum, 310131 Shambat, SUDAN, TEL+249-11-310131

### Abdisalam I. Khatibu

National Prolect Coordinafor and Direcror, FAO Ir-rigated Rice Production, Zanzibar, TANZANIA

### Edward A. Baryeh

Professor, Africa University, P.O.Box 1320, Mutare, ZIMBABWE

### Solomon Tembo

52 Goodrington Drive, PO Mabelreign, Sunridge, Harare, ZIMBABWE

## -AMERICAS-

### Hugo Alfredo Cetrangolo

Full Professor and Director of Food and Agribusi-ness Program Agronomy College Buenos Aires University, Av. San Martin 4453, (1417) Capital Fed-eral, ARGENTINA TEL+54-11-4524-8041/93, FAX+54-11-4514-8737/39 E-mail: cetrango@agro.uba.ar

### Irenilza de Alencar Nääs

Professor, Agricultural Engineering College, UNI-CAMP, Agricultural Construction Dept., P.O. Box 6011, 13081 -Campinas- S.P., BRAZIL TEL+55-19-7881039, FAX+55-19-7881010 E-mail: irenilza@agr.unicamp.br

### A. E. Ghaly

Professor, Biological Engineering Department Dalhousie University, P.O. Box 1000, Halifax, Nova Scotia, B3J2X4, CANADA TEL+1-902-494-6014, FAX+1-902-423-2423 E-mail: abdel.gahaly@dal.ca

### Edmundo J. Hetz

Professor, Dept. of Agric. Eng. Univ. of Concepcion, Av. V.Mendez 595, P.O. Box 537, Chillan, CHILE TEL+56-42-216333, FAX+56-42-275303 E-mail: ehetz@udec.cl

### A. A. Valenzuela

Emeritus Professor, Ag. Eng. Fac., University of Concepcion, Casilla 537 Chillan, CHILE TEL+56-42-223613, FAX+56-42-221167

### Roberto Aguirre

Associate Professor, National University of Colom-bia, A.A. 237, Palmira, COLOMBIA TEL+57-572-2717000, FAX+57-572-2714235 E-mail: ra@palmira.unal.edu.co

### Omar Ulloa-Torres

Professor, Escuela de Agricultura de la Region, Tropical Humeda (EARTH), Apdo. 4442- 1000, San Jose, COSTA RICA, TEL+506-255-2000, FAX +506-255-2726, E-mail: o-ulloa@ns.earth.ac.cr

### S. G. Campos Magana

Leader of Agric. Engineering Dept. of the Gulf of Mexico Region of the National Institute of Forestry and Agricultural Research, Apdo. Postal 429. Vera-cruz, Ver. MEXICO



I de A Nääs



A E Ghaly



E J Hetz



A A  
Valenzuela



R Aguirre



O Ulloa-Torres



S G C  
Magana



H Ortiz-Laurel



W J  
Chancellor



M R Goyal



A K Mahapatra



G R Quick



S M Farouk



Daoulat Hussain



M A Mazed



Chetem Wangchen



Wang Wanjun



S Illangantileke



S M Ilyas



A M Michael



G Singh



T P Ojha



S R Verma



Soedjatmiko



M Behrooz-Lar



Saeid Minaei



J Sakai



B A Snobar



C J Chung



C C Lee

### Hipolito Ortiz-Laurel

Head of Agric. Engineering and Mechanization Dept./ Postgraduate College, Iturbide 73, Salinas de Hgo, S.L.P., C.P. 78600, MEXICO  
TEL+52-496-30448, FAX+52-496-30240

### William J. Chancellor

Professor Emeritus, Bio. and Agr. Eng. Dept., Univ. of California, Davis, CA, 95616, U.S.A.  
TEL+1-530-753-4292, FAX+1-530-752-2640  
E-mail: wjchancellor@ucdavis.edu

### Megh R. Goyal

Prof./Agric & Biomedical Engineering, University of Puerto Rico, P.O.Box 0086, RINCON, Puerto Rico, 00677-0086, U.S.A., TEL+1-939-697-8039

### Ajit K. Mahapatra

Present add: Agric. & Biosystems Eng. Dept., South Dakota State Univ., P.O. Box 2120 Brookings, SD 57007-1496, U.S.A., TEL605-6885291, FAX 605-6886764, E-mail: mahapatra@sdsstate.edu

## -ASIA and OCEANIA-

### Graeme R. Quick

Consulting Engineer, 83 Morrisons Road, Peaches-ter, Queensland, 4519, AUSTRALIA

### Shah M. Farouk

Professor (Retd.), Farm Power & Machinery Dept., Bangladesh Agricultural University, Mymensingh 2200, BANGLADESH, TEL+880-91-5695ext.2596, FAX91-55810, E-mail: smf@bdcom.com

### Daulat Hussain

Dean, Faculty of Agric. Engineering and Technology, Bangladesh Agricultural University, Mymensingh-2202, BANGLADESH, TEL+880-91-52245, FAX91-55810, E-mail: dhussain@royalaten.net

### Mohammed A. Mazed

Member-Director, Bangladesh Agri. Res. Council, Farmgate, Dhaka, BANGLADESH  
E-mail: mamazed@barcbgd.org

### Chetem Wangchen

Programme Director Agricultural Machinery Centre Ministry of Agriculture Royal Government of Bhutan, Bondey Paro Bhutan 1228, BHUTAN, E-mail: krtamc@druknet.bt

### Wang Wanjun

Past Vice Director and Chief Engineer/Chinese Academy of Agricultural Mechanization Sciences, 1 Beishatan, Beijing, 100083, CHINA

TEL+86-(0)83-001-6488-2710, FAX001-6488-2710  
E-mail: wwj@isp.caams.org.cn

### Sarath Illangantileke

Regional Representative for South and West Asia, International Potato Center (CIP), Regional Office for CIP-South & West Asia, IARI (Indian Agric. Res. Institute) Campus, Pusa, New Delhi-12, 110002, INDIA, TEL+91-11-5719601/5731481, FAX./5731481, E-mail: cip-delhi@cgiar.org

### S. M. Ilyas

Director, National Academy of Agricultural Research Management (NAARM), Rajendranagar, Hyderabad-500030, INDIA, Tel+91-40-24015070, Fax:+91-41-24015912, E-mail: smiyas@city.com

### A. M. Michael

1/64, Vattekkunnam, Methanam Road, Edappally North P.O., Cochin, 682024, Kerala State, S. INDIA

### Gajendra Singh

Professor, Gajendra Singh, Former Vice Chancellor, Doon University 260, SFS Flats, Ashok Vihar Phase IV, Delhi-110052 INDIA, TEL+91-11-2730 7664, Email: prof.gsingh@gmail.com

### T. P. Ojha

Director General(Engg.) Retd., ICAR, 110, Vineet Kung Akbarpur, Kolar Road, Bhopal, 462 023, INDIA  
TEL+91-755-290045

### S. R. Verma

Ex-Dean & Professor of Agr. Engg., H. No. 14, Good Friends Colony, Barewal Road, Ludhiana 141012. Punjab, INDIA, TEL+91-161-2551096  
E-mail: srverma10@yahoo.com

### Soedjatmiko

President, MMAI(Indonesian Soc. of Agric. Eng. & Agroindustry), Menara Kadin Indonesia Lt.29 Jl. HR. Rasuna Said X-5/2-3 Jakarta, 12940, INDONESIA  
TEL+62-(0)21-9168137/7560544, FAX(0)21-527448 5/274486/7561109

### Mansoor Behrooz-Lar

Professor, Agr. Machinery, Ph.D, Tehran University Faculty of Agriculture, Karaj, IRAN  
TEL+98-21-8259240, E-mail: mblar@chmran.ut.ac.ir

### Saeid Minaei

Assistant Professor, Dept. of Agr. Machinery Eng., Tarbiat Modarres Univ., P.O.Box 14115-111, Tehran, IRAN  
TEL+9821-6026522-3(office ext.2060, lab ext.2168)  
FAX+9821-6026524, E-mail: minaee7@hotmail.com

### Jun Sakai

Professor Emeritus, Kyushu University, 2-31-1 Chihaya, Higashi-ku, Fukuoka city, 813, JAPAN  
TEL+81-92-672-2929, FAX+81-92-672-2929  
E-mail: junsakai@mtj.biglobe.ne.jp

### Bassam A. Snobar

Professor and Vice President, Jordan University of Science and Technology, P.O.Box 3030 Irbid, 22110, JORDAN, TEL+962-2-295111, FAX+962-2-295123  
E-mail: snobar@just.edu.jo

### Chang Joo Chung

Emeritus Professor, Seoul National University, Agricultural Engineering Department, College of Agriculture and Life Sciences, Suwon, 441-744, KOREA  
TEL+82-(0)331-291-8131, FAX+82-(0)331-297-7478  
E-mail: chchung@hanmail.net

### Chul Choo Lee

Mailing Address: Rm. 514 Hyundate Goldentel Bld. 76-3 Kwang Jin Ku, Seoul, KOREA  
TEL+82-(0)2-446-3473, FAX+82-(0)2-446-3473  
E-mail: ccsllee@chollian.net

### Muhamad Zohadie Bar daie

Professor, Department of Agricultural and Biosystems Engineering, University Putra Malaysia, 43400 upm, Serdang, Serdangor, MALAYSIA  
TEL+60-3-89466410  
Email: zohadie@eng.upm.edu.my

### Madan P. Pariyar

Consultant, Rural Development through Selfhelp Promotion Lamjung Project, German Technical Cooperation. P.O. Box 1457, Kathmandu, NEPAL

### David Boakye Ampratwum

Associate Professor, Dept. of Bioresource and Agricultural Engineering, College of Agriculture, Sultan Qaboos University, P.O. Box 34, Post Code 123, Muscat, Sultanate of Oman, OMAN  
TEL+968-513866, FAX513866  
E-mail: davidamp@squ.edu.om

### EITag Seif Eldin

Mailing Address: Dept. of Agric. Mechanization, College of Agriculture, P.O. Box 32484, Al-Khod, Sultan Qaboos University, Muscat, Sultanate of Oman, OMAN

### Allah Ditta Chaudhry

Professor and Dean Faculty of Agric. Engineering and Technology, University of Agriculture, Faisalabad, PAKISTAN



M Z Bar daie



M P Pariyar



D B Ampratwum



E S Eldin



A D Chaudhry



A Q Mughal



R ur Rehmen



B T Devrajani



N A Abu-Khalaf



Surya Nath



R M Lantin



R P Venturina



S A Al-Suhaibani



A M S Al-Amri



S F Chang



T S Peng



S Krishnasreni



S Phongsupasamit



C Rojanasaroj



V M Salokhe



Y Pinar



I Haffar



N Hay



P V Lang



A A Hazza'a



A P Kaloyanov



P Kic



J Müller



G Pellizzi



W B Hoogmoed

### A. Q. A. Mughal

Vice Chancellor, Sindh Agriculture University, Tandojam, PAKISTAN

### Rafiq ur Rehman

Director, Agricultural Mechanization Reserch Institute, P.O. Box No. 416 Multan, PAKISTAN

### Bherulal T. Devrajani

Professor and Chairman, Faculty of Agricultural Engineering, Sindh Agriculture University, Tandojam, Sindh, PAKISTAN  
TEL+92-2233-5594

### Nawaf A. Abu-Khalaf

Engineer, the Project Directorate in Palestinian Agricultural Ministry, P.O.Box 405, Hebron, PALESTINE  
Telfax: 972-2-2227846/7  
E-mail: nawafu@hotmail.com

### Surya Nath

Assoc. Prof., Dept. of Agriculture, Papua New Guinea University of Technology, Private Mail Bag, Lae, PAPUA NEW GUINEA, TEL+675-475-5162, FAX473-4477, E-mail: Nath@datec.net.pg

### Reynaldo M. Lantin

Professor, College of Engineering and Agro-Industrial Technology University of the Philippines Los Banos, Laguna 4031, PHILIPPINES  
TEL+63-(0)49-536-2792, FAX+63-(0)49-536-2873  
E-mail: rmlantin@emudspring.uplb.edu.ph

### Ricardo P. Venturina

President & General Manager, Rivelisa publishing House, 215 F, Angeles St. cor Taft Ave. Ext., 1300 Pasay City, Metro Manila, PHILIPPINES

### Saleh Abdulrahman Al-suhaibani

Professor, Agricultural Engineering Dept., College of Agriculture, King Saud University, P.O. Box 2460 Riyadh 11451, SAUDI ARABIA

### Ali Mufarreh Saleh Al-Amri

Professor, Dept. of Agric. Engineering, Colleg of Agricultural and Food Sciences, King Faisal University, Al-Ahsa, SAUDI ARABIA  
E-Mail: aamri@kfu.edu.sa, aamri2020@yahoo.com

### Sen-Fuh Chang

Professor, Agric.-Machinery Dept. National Taiwan University, Taipei, TAIWAN

### Tieng-song Peng

Deputy Director, Taiwan Agricultural Mechanization Research and Development Center. FL. 9-6, No. 391 Sinyi Road, Sec. 4, TAIWAN

### Suraweth Krishnasreni

Senior Expert in Agricultural En-gineering, Department of Agriculture, Chatuchak, Bangkok 10900, THAILAND  
Tel5792153,5794497,5798520,Ext.124, Fax9405791,  
E-mail: Suraweth@doa.go.th

### Surin Phongsupasamit

President, Institute for Promotion of Teaching Science and Technology, 924 Sukumit Rd. Klong Toey Bangkok, THAILAND

### Chanchai Rojanasaroj

Research and Development Engineer, Dept. of Agriculture, Ministry of Agriculture and Cooperatives, Gang-Khen, Bangkok 10900, THAILAND

### Vilas M. Salokhe

Professor, AFE Program, Asian Institute of Technology, P.O. Box 4, Klang Luang. Pathumthani 12120, THAILAND, TEL+66-2-5245479, FAX+66-2-5246200  
E-mail: salokhe@ait.ac.th

### Yunus Pinar

Professor, and Head, Agric. Machinery Dept, Faculty of Agriculture, University of Ondokuz Mayıs, Kurupelit, Samsun, TURKEY

### Imad Haffar

Associate Professor of Agric. Engineering, Faculty of Agricultural Sciences, United Arab Emirates University, Al Ain, P.O. Box 17555, UAE, Tel+971-506436385, E-mail: haffar96@emirates.net.ae

### Nguyen Hay

Associate Professor, Dean of Faculty of Engineering, Nonglam University, Linh Trung Ward, Thu Duc District, Ho Chi Minh City, VIET NAM  
E-mail: nguyenhay@hcm.fpt.vn

### Pham Van Lang

Director, Vietnam Institute of Agricultural Engineering, A2-Phuong Mai, Dong Da Hanoi, VIET NAM

### Abdulsamad Abdulmalik Hazza'a

Professor and Head of Agricultural Engineering Department, Faculty of Agriculture, Sana'a University, P.O.Box 12355, Sana'a YEMEN, Tel+9671-407300, Fax:9671-217711, E-mail: hazaia@yahoo.com

## -EUROPE-

### Anastas Petrov Kaloyanov

Professor & Head, Research Laboratory of Farm Mechanization, Higher Institute of Economics, Sofia, BULGARIA

### Pavel Kic

Vice-Dean/Technical Faculty, Czech University of Agriculture Prague, 16521 Prague 6-Suchdol, CZECH, Tel+420-2-24383141, Email: KIC@TFC.ZU.CZ

### Joachim Müller

Full Professor at the University Hohenheim, Institute of Agricultural Engineering, Head of Agricultural Engineering in the Tropics and Subtropics, University of Hohenheim, 70593 Stuttgart, GERMANY, Tel+0711-459-22490, E-mail: joachim.muller@uni-hohenheim.de

### Giuseppe Pellizzi

Director of the Institute of Agric. Engineering of the University of Milano and Professor of Agric. Machinery and Mechanization, Via G. Celoria, 2-20133 Milano, ITALY, Tel+39-02-503-16871, E-mail: giuseppe.pellizzi@Unimi.it

### W. B. Hoogmoed

University Lecturer, Faculty of Lsg Agrarische Bedrijfstechologie, Wageningen University, Agrotechnologie en Voedingwetenschappen, Bornsesteeg 59, 6700 AA, Wageningen, P.O.Box 17, NETHERLAND, E-mail: willem.hoogmoed@wur.nl

### Jan Pawlak

Professor, head of the Dept. of Economics and Utilization of Farm Machines at IBMER, Professor at the Univ. of Warmia and Mazury in Olsztyn, Fac. of Tech. Sci., POLAND

### Oleg S. Marchenko

Professor and agricultural engineer, Department Head in All-Russia Research Institute for Mechanization in Agriculture (VIM), 1st Institut'sky proezd, 5, Moscow 109428, RUSSIA, Tel+7(095)174-8700, Fax+7(095)171-4349, E-mail: oleg072000@mail.ru

### John Kilgour

Senior Lecturer in Farm Machinery Design at Silsoe College, Silsoe Campus, Silsoe, Bedford, MK45 4DT, UK

### Milan Martinov

Professor, Faculty of Engineering, Chair for Biosystems Engineering, Novi Sad, SERBIA, TEL+ 381-21-485-2369, Fax+ +381-21-635-0592 E-mail: MilanMartinov@uns.ac.rs



Jan Pawlak



O S Marchenko



J Kilgour



M Martinov

### Vol.39, No.2, Spring, 2008

Tillage Implements Performance and Effect on Some Soil Physical Properties (Elsamawal Khalil Makki, Abdelmoniem Elamin Mohamed) ..... 9

Studies on Characterization of Selected Plant Oils and Their Bio-Diesels (P. K. Gupta, Rakesh Kumar, B. S. Panesar)..... 14

Efficient Utilization of Conventional Fuel Through the Improvement of Traditional Stove (Syedul Islam, Abul Quasem, Abdur Rahman, Mohammad Nasim, Abdul Baqui, Farah Naz Khan) ..... 19

Development and Evaluation of Anaerobic Type Sprouted Rice Drum Seeder and to Ascertain the Physiological Load on the Operator (R. S. Devnani)..... 23

Evaluation and Improvement in Design of Self Propelled Vertical Conveyer Reaper (L. P. Singh, V. R. Vagadia, K. K. Jain, A. H. Memon)..... 34

Energy Requirement of Different Weed Management Practices for Aerobic Rice in India (V. P. Chaudhary, S. K. Sharma, D. K. Pandey)..... 39

Effect of Selected Parameters on the Performance of Semi-automatic Vegetable Transplanter (S. K. Satpathy, I. K. Garg) ..... 47

Design and Construction of the Airtight Ferrocement Bin for On-farm Storage of Paddy (T. B. Adhikarinayake, J. Müller, J. oostdam)..... 52

The Situation of Agricultural Mechanization in Sarab City - Iran (V. Rasooli Sharabani)..... 57

Development and Performance Evaluation of Mat Type Nursery Raising Device (S. C. Sharma, T. P. Singh)..... 64

Development of a Prototype Dehuller for Pretreated Chickpea (B. Sanjeeva Reddy, V. Maruthi)..... 71

Study on Intelligent Measurement and Analysis System of Soil Electric Conductivity (He Yong, Chen Yongjun, Wu Yanping)..... 76

Design and Development of a Machine for Aonla Seed Removal (Ambrish Ganachari, K. Thangavel, D. Manohar Jesudas, R. Viswanathan)..... 80

Agricultural Mechanization in Bangradesh (K. C. Roy, Gajendra Singh)..... 83



### Vol.39, No.3, Summer, 2008

Designing a Fonio Mill; Screening an Operating Principle and Its Validation (C. Marouze, P. Thauunay, G. Fliedel, J. F. Cruz).....9

A Model to Predict Anthropometric Dimensions of Farm Workers of South India (K. Kathirvel, B. Suthakar, R. Manian) ..... 16

Development and Performance Evaluation of Manure Spreading Attachment to Two Wheel Trailer (B. Suthakar, K. Kathirvel, R. Manian, D. Manohar Jesudas) ..... 22

Development of Power Tiller Operated Groundnut Harvester (S. H. Suryawanshi,

B. Shridar, K. Kathirvel)..... 29

Development of High Capacity Fodder Densification Machine (S. K. Jha, A. Singh, Adarsh Kumar, J. S. Panwar)..... 33

A Review of Draught Animal Power as a Prime Mower for Site Specific Operations (C. P. Doshi, G. Tiwari)..... 37

Studies on Storage Characteristics of Betel Leaves (K. Rayaguru, K. Khan, G. Sahoo, M. K. Panda)..... 42

Prospects of Paddy Cultivation Mechanization in Hills of Himachal Pradesh (Sukhbir Singh, D. K. Vasta, H. N. Verma)..... 46

Design, Development and Evaluation of Manual-Cum-Bullock Operated Zero-Till Seed-Cum Fertilizer Drill for Hills (K. P. Singh, Subhash Chandra, R. Bhattacharya, A. K. Srivastva, H. S. Gupta)..... 50

Performance Evaluation of Two On-farm Feed Mixers (A. Addo, A. Bart-Plage)..... 57

Design and Evaluation of Aquifer Water Thermal Control System for Greenhouse (V. P. Sethi, S.K. Sharma)..... 61

Drying of Fruits with Sorar Tunnel Dryer (A. N. Udroui, D. G. Epure, A. Mitoroi, M. A. Helmy)..... 68

A Methodology for Performance Evaluation of Puddling Equipment (A. K. Dave, Ajay Kumar Sharma, S. K. Rartaray)..... 71

Effect of Relative of Picking Tyne, Ground Clearance and Quantity of Trash Left on Collection Efficiency of the Sugarcane Trash Collector (G. Aravindareddy, R. Manian, K. Kathirvel) ..... 75



### Vol.39, No.4, Autumn, 2008

Biomass Heat-Emission Characteristics of Energy Plants (Jan Malařák, A. K. Gürdil, Petr Jevic, K. Çagatay Selvi) ..... 9

Comparative Grain Supply Chain in Canada and China (L. Fan, D. S. Jayas) ..... 14

Investigation into Farm Mechanization Practices for Cassava and Yam in Rivers State, Nigeria (S. O. Nkakini, O. Ceder) ..... 22

Domestic Solar Geyser Cum Distiller (S. H. Sengar, A. K. Kurchania)..... 28

Laser Guided Land Leveler: Precession Leveler With Laser Technology for Land Preparation (B. Suthakar, K. Kathirvel, R. Manian, D. Manohar Jesudas) ..... 30

Development and Testing of Engine Operated Pneumatic Cotton Picker (A. Yajuddin)..... 37

The Effect of Two Type of Plows With Four Speeds on the Field Capacity and Bulk Density (Ali Mazin Abdul-Munaim, Maysm Thamer Al-Hadidy) ..... 39

Development and Evaluation of Direct Paddy Seeder for Assessing the Suitability to Rural Woman (D. Sirisha, K. Kathirvel, R. Manian)..... 41

Development and Evaluation of Farm Level Turmeric Processing Equipment (U. S. Pal, K. Khan, N. R. Sahoo, G. Sahoo)..... 46

Effect of Threshing Cylinders on Seed Dam-

age and Viability of Moongbean (*Virna radiate*. (L.) Wilezee) (Shiv Kumar Lohan) 51

Engineering the Application of Grain Protectants on F1 Hybrid Rice Seed: The Philippine-HRCP Experience (Ricardo F. Orge, John Eric O. Abon)..... 55

Development and Performance of a Solar-Cum-Gas Fired Dates Dryer (Munir Ahmad, Asif A. Mirani)..... 63

Formation of Generalized Experimental Models for Double Roller Gin (P. G. Patil, P. M. Padole, J. F. Agrawal, A. B. Dahake)..... 69

Preservation and Storage of Perishable Fresh Fruits and Vegetables in the Lowlands of Papua New Guinea (Surya Nath, Simon Sil) ..... 75

Annual Costs of Mechanizing With Tractors in Tanzania (Sylvester Mpanduji, Baanda Salim)..... 81



### Vol.40, No.1, Winter, 2009

Comparative Evaluation of Different Groundnut Digging Blades (S. H. Suryawanshi, B. Shridar, K. Kathirvel) ..... 9

Designing and Testing an Improved Maize Sheller (I. K. Tastra) ..... 12

Development of a Chopping Machine for Agricultural Residue (a Case Study on Grape Trashes) ( Ismail Fouad Sayed-Ahmad, N. El-Desoukey, M. A. Metwally, A. B. El-Nagar)..... 18

Establishment and Performance of Indegenous Small Scale Rice Processing Plant in Nigeria (Gbabo Agidi)..... 25

Development and Performance Evaluation of a Garlic Bulb Breaker (V. D. Mudgal, S. B. Sahay)..... 32

Mechanized Rice Cultivation in Bangladesh: Past Experiences and Future Potentials (Syedul Islam, S. M. M. Rahman, M. A. Rahman, M. A. Quasem, M. D. Huda, AKM S. Islam, M. Ahiduzzaman, M. G. K. Bhuiyan, M. A. Hossen, M. A. Baqui)..... 36

Status of Farm Power Availability in the Selected Villages of Jammu District (J & K States) (Sushil Sharma) ..... 41

Indoor Storage of Paddy-Rice in the Lowlands of Papua New Guinea (Surya Nath) .. 46

Threshing Unit Losses Prediction for Thai Axial Flow Rice Combine Harvester (Somchai Chuan-Udom, Winit Chinsuwan) ..... 50

Development and Performance Evaluation of Prototype Double Roller Gin (P. G. Patil, P. M. Padole, J. F. Agrawal, A. B. Dahake) ... 55

Impact of Tillage and Nutrient Management in Maize-Wheat Crop Rotation Under Dryland Cultivation (J. P. Singh, Vikas Abrol, Syed Zameer Hussain)..... 60

Status of Post Harvest Technology of Guar (*Cyamopsis Tetragonoloba*) in India (R. K. Vishwakarma, S. K. Nanda, U. S. Shivhare, R. T. Patil)..... 65

Constraction and Performance Evaluation of a Local Device for Separating Sunflower

Seeds and Environment Preservation (A. Lofty).....	73
Design of a Pollination Device for Palm Tree (I. Yehia).....	78
Small Scale on Farm Mechanization in Walnut Cultivation (Junaid N. Kahn, Jagvir Dixit, Navin C. Shahi).....	81



**Vol.40, No.2, Spring, 2009**

Design and Performance Evaluation of a Small Tractor-Simulator (Indra Mani, J. S. Panwar).....	9
Farm Power Status and Its Utilization Pattern in Nalanda District of Bihar - A Case Study (V. B. Shambhu, J. P. Gupta, S. K. Jha, Sanjay Kumar).....	13
Evaluation of a Nylon Towrope for Buffering Pulling Forces of Animal-drawn Utility Wagons (Timothy M. Harrigan, Richard J. Roosenberg).....	22
The Influence of Some Parameters to Quality of Brown Rice After Husking on Small Productivity Rice Husker in the Rural Areas of Lamdong Province (Nguyen Hay, Pham Can).....	27
Improved Cost Effective Implements for Small Rice Farmers (Jagvir Dixit, J. N. Khan).....	30
Development and Modeling of Mobile Disintegrator (S. M. Bhende, N. P. Awate, D. S. Karale, S. P. Trikal, V. P. Khambalkar).....	36
Development and Performance Evaluation of Tractor Operated Plant Uprooter for Castor Crop (H. B. Solanki, Rajvir Yadav).....	41
Design, Development and Evaluation of a Peanut Sheller (M. A. Rostami, F. Azadshahraki, H. Najafinezhad).....	47
Factors Affecting Breaking Force Distribution of Wheat Kernel Before Milling (I. E. A. Elbatawi).....	50
Development of Tillage Machinery for Conservation Agriculture in Bangladesh (K. C. Roy, M. E. Haque, Scott Justice, Israil Hossain, C. A. Meisner).....	58
Development and Performance Evaluation of a Tractor Operated Cotton Stalk Shredder Cum Insitu Applicator (T. Senthilkumar, R. Manian, K. Kathirvel).....	65
Design Development and Performance Evaluation of Cotton Loading and Unloading Machine for Heaping (S. K. Shukla, V. G. Arude, P. G. Patil).....	68
Ergonomically Designed Thresher (S. V. Gole, Rashmi Shahu).....	73
Study of Kharang Grader in Bhutan (Ugyen Drukpa, Chetem Wangchen, Karma Thinley, Hai Sakurai).....	76
Biomass Utilization for Thermal Energy (Gürkan A. K. Gürdil, Jan Malaták, K. Çağatay Selvi, Yunus Pinar).....	80



**Vol.40, No.3, Summer, 2009**

Parasol Sprayer for Efficient Chemical Application in Dwarf and Semi Dwarf Mango Orchards (C. Ramana, D. Manohar Jesudas).....	9
Development of Rice Cleaner for Reduced Impurities and Losses (M. N. El-Awady, I.	

Yehia, M. T. Ebaid, E. M. Arif).....	15
Evaluation of a Handy Tool for Sugacane De-Trashing (G. Kathiresan).....	21
Performance of a Mixed-Mode Type Solar Crop Dryer in Drying Rough Rice Under Natural Convection (M. A. Basunia, T. Abe).....	23
Research on Shear Characteristics of Chinese Cabbage Rootstalk (Xu Liming, Yao Huiling).....	30
Design, Development and Performance Evaluation of Rota Drill (Muhammad Yasin, Muhammad Anjum Ali).....	35
Effect of Seedlings Age on Performance of Rice Transplanter (Aswini K. Goel, S. Swain, Debaraj Behera).....	41
Development of a Motorized Stationary Sorghum Thresher (K. J. Simonyan).....	47
Performance Enhancement of Traditional Unpeeled Longan Dryers with Design Modification (Nakorn Tippayawong, Chutchawan Tantakitti, Satis Thavornnun).....	56
Conversion of Large Diesel Engine to Run on Biogas for High Efficiency Electrical Power Generation (S. Siripornakarachai, T. Sucharitakul).....	59
Empirical Equations to Predict the Tractor Center of Gravity (S. M. Abd El Aal).....	64
The Utilization of a Drilling Planter for Rice Band Sowing (Ismail, Z. E).....	69
Optimum Tilt Angle and Orientation for a Flat Plate Solar Water Heater under Egyptian Conditions (Salah, M. Abdellatif, Nasser, M. Elashmay, Ahmed, M. Kassem).....	73
Performance Evaluation of Locally Fabricated Electric Dryer (Pema Dakpa, Hai Sakurai, Ugyen Penjore).....	78
Liquid Wastes from Methyl Ester Oil Production and Thermal-Emission Properties (Gürkan A. K. Gürdil, Jan Malaták K. Çağatay Selvi, Yunus Pinar).....	83



**Vol.40, No.4, Autumn, 2009**

Soil Response to Tillage Treatments (Ismail, Zakarya Ebrahen).....	9
Status of Biogas Technology in Akola District of Maharashtra State (V. P. Khambalkar, S. R. Gadge, Shilpa B. Dahatonde, D. S. Karale).....	15
Prediction of Surface Area of Garden Egg ( <i>Solanum Aethiopicum</i> L) from Weight Measurements (R. J. Bani, E. Y. Kra, J. Amoah, M. Aggey).....	20
Farm Mechanization Status and Future Strategies for Major Cereal and Horticultural Crops in Kashmir (Jagvir Dixit, J. N. Khan, R. M. Shukla).....	23
Ergonomics of Self Propelled Power Weeders as Influenced by Forward Speed and Terrain Condition (K. Kathirvel, S. Thambidurai, D. Ramesh, D. Manohar Jesudas).....	28
A Simple Milk Churner for Ghee-Making (Abdub Muyanja, John B. Kawongolo, William S. Kisaalita).....	34
Detection of Stress Cracks in Rice Kernels Based on Machine Vision (Xu Lizhang, Li Yaoming).....	38
Economical Evaluation of Mechanization Alternatives for Small Horticulturist in Chillán-Chile (Marco López, Edmundo	

Hetz, Claudio Villagra).....	42
Mechanical Harvesting of Fodder Maize as Influenced by Crop, Machine and Operational Parameters (K. Kathirvel, B. Suthakar, D. Manohar Jesudas).....	52
A Hand Operated White Pepper Peeling Machine (V. Thirupathi, R. Viswanathan).....	57
Performance Evaluation of a Divergent Roller Grader for Selected Vegetables (S. Shahir, V. Thirupathi).....	60
Development of Low Cost, Bullock Drawn, Multi-Purpose Implement for Sandy Loam Soil (V. K. Chandegara).....	63
Development and Evaluation of a Tractor-Operated Sugarcane Cleaner (Sanjay Khar, L. N. Shukla).....	70
Design and Development of Compact Desiccant Seed Dryer (S.S. Dhaliwal, Sukhmeet Sing, Parm Pal Singh).....	75
Test Results of "Aqusearch Pm-600" Moisture Meter of "Kett Electric Laboratory" (Japan) (Pugachyov P. M., Levina N. S., Shalayeva L. A., Kotov M. G.).....	81



# INSTRUCTIONS TO AMA CONTRIBUTORS

The Editorial Staff of the AMA requests of articles for publication to observe the following editorial policy and guidelines in order to improve communication and to facilitate the editorial process:

## Criteria for Article Selection

Priority in the selection of article for publication is given to those that –

- a. are written in the English language;
- b. are relevant: to the promotion of agricultural mechanization, particularly for the developing countries;
- c. have not been previously published elsewhere, or, if previously published are supported by a copyright permission;
- d. deal with practical and adoptable innovations by, small farmers with a minimum of complicated formulas, theories and schematic diagrams;
- e. have a 50 to 100-word abstract, preferably preceding the main body of the article;
- f. are printed, double-spaced, under 3,000 words (approximately equivalent to 6 pages of AMA-size paper) ; and those that
- g. art: supported by authentic sources, reference or bibliography.
- h. written on floppy disc or CD-R

## Rejected/Accepted Articles

- a. As a rule, articles that are not chosen for AMA publication are not returned unless the writer(s) asks for their return and are covered with adequate postage stamps. At the earliest time possible, the writer(s) is advised whether the article is rejected or accepted.
- b. When an article is accepted but requires revision/modification, the details will be indicated in the return reply from the AMA Chief Editor in which case such revision/modification must be completed and returned to AMA within three months from the date of receipt from the Editorial Staff.
- c. "The AMA does not pay for articles published. However, the writers are given collectively 5 free copies (one copy air-mailed and 4 copies sent by surface/sea mail) of the AMA issue wherein their articles are published. In addition, a single writer is given 25 off-prints of the article and plural writers are given 35 off-prints (also sent by surface/sea mail)"
- d. Complimentary copies: Following the publishing, three successive issue are sent to the author(s).

## Procedure

- a. Articles for publication (original and one-copy) must be sent to AMA through the Co-operating Editor in the country where the article originates. (Please refer to the names and addresses of Co-operating Editors in any issue of the AMA). However, in the absence of any Co-operating Editor, the article may be sent directly to the AMA Chief Editor in Tokyo.
- b. Contributors of articles for the AMA for the first time are required to attach a passport size ID photograph (black and white print preferred) to the article. The same applies to those who have contributed articles three years earlier. In either case, ID photographs

taken within the last 6 months are preferred.

- c. The article must bear the writer(s) name, title/designation, office/organization, nationality and complete mailing address.

## Format/Style Guidance

- a. Article must be sent on 3.5 inch floppy disk or CD-R with MS DOS format (e.g. Word Perfect, Word for DOS, Word for Windows... **Absolutely necessary TEXT FORMAT**) along with two printed copy (A4).
- b. The data for graphs and the black & white photographs must be enclosed with the article.
- c. Whether the article is a technical or popular contribution, lecture, research result, thesis or special report, the format must contain the following features:
  - (i) brief and appropriate title;
  - (ii) the writer(s) name, designation/title, office/organization; and mailing address;
  - (iii) an abstract following ii) above;
  - (iv) body proper (text/discussion);
  - (v) conclusion/recommendation; and a
  - (vi) bibliography
- d. The printed copy must be numbered (Arabic numeral) successively at the top center whereas the disc copy pages should not be number. Tables, graphs and diagrams must likewise be numbered. Table numbers must precede table titles, e.g., "Table 1. Rate of Seeding per Hectare". Such table number and title must be typed at the top center of the table. On the other hand, graphs, diagrams, maps and photographs are considered figures in which case the captions must be indicated below the figure and preceded by number, e.g., "Figure 1. View of the Farm Buildings".
- e. **The data for the graph must also be included. (e.g. EXCEL for Windows)**
- f. Tables and figures must be preceded by texts or discussions. Inclusion of such tables and figures not otherwise referred to in the text/discussion must be avoided.
- g. Tables must be typed clearly without vertical lines or partitions. Horizontal lines must be drawn only to contain the sub-title heads of columns and at the bottom of the table.
- h. Express measurements in the metric system and crop yields in metric tons per hectare (t/ha) and smaller units in kilogram or gram (kg/plot or g/row).
- i. Indicate by footnotes or legends any abbreviations or symbols used in tables or figures.
- j. Convert national currencies in US dollars and use the later consistently.
- k. Round off numbers, if possible, to one or two decimal units, e.g., 45.5 kg/ha instead of 45.4762 kg/ha.
- l. When numbers must start a sentence, such numbers must be written in words, e.g., Forty-five workers..., or Five tractors..."instead of 45 workers..., or, 5 tractors.

## **INQUIRY and REQUEST to AMA**

Please let us know your need. We shall promptly reply them. Inquire on any catalog listed in the advertisement in this issue. We shall try our best to serve you.

We welcome articles of interest to agricultural mechanization.

Fill in the reverse side of this card and send us by sealed letter.

**FARM MACHINERY INDUSTRIAL RESEARCH CORP.**

**2-7-22 Kanda nishikicho, Chiyoda-ku, Tokyo 101-0054, Japan**

## ADVERTISED PRODUCT'S INQUIRY

Product	Advertiser	Vol., No., Page

## EDITORIAL REQUEST TO AMA

---

---

---

---

---

Your Name :

Address :

Occupation :



## SUBSCRIPTION/ORDER FORM

AGRICULTURAL MECHANIZATION IN ASIA, AFRICA AND LATIN AMERICA ( AMA )

Issued Quarterly

Subscription Rate (includes surface mail postage)

Annual (4 issues)..... ¥ 6,000

Single copy..... ¥ 1,700

Back Issues (1971-75, ¥ 2,000 per copy)  
(1976-77, ¥ 1,200 per copy)  
(1978-80, ¥ 1,500 per copy)

- |                                                                            |                                                              |                                                               |
|----------------------------------------------------------------------------|--------------------------------------------------------------|---------------------------------------------------------------|
| <input checked="" type="checkbox"/> Spring, 1971                           | <input type="checkbox"/> Vol.7 No.2, Spring, 1976            | <input checked="" type="checkbox"/> Vol.9 No.4, Autumn, 1978  |
| <input checked="" type="checkbox"/> Vol.2 Autumn, 1971                     | <input type="checkbox"/> Vol.7 No.3, Summer, 1976            | <input type="checkbox"/> Vol.10 No.1, Winter, 1979            |
| <input type="checkbox"/> Vol.3 No.1, 1972                                  | <input type="checkbox"/> Vol.7 No.4, Autumn, 1976            | <input type="checkbox"/> Vol.10 No.2, Spring, 1979            |
| <input type="checkbox"/> Vol.3 No.2, Summer, 1972                          | <input type="checkbox"/> Vol.8 No.1, Winter, 1977            | <input type="checkbox"/> Vol.10 No.3, Summer, 1979            |
| <input checked="" type="checkbox"/> Vol.4 No.1, Spring, 1973               | <input type="checkbox"/> Vol.8 No.2, Spring, 1977            | <input type="checkbox"/> Vol.10 No.4, Autumn, 1979            |
| <input type="checkbox"/> Vol.4 No.2, Autumn, 1973                          | <input type="checkbox"/> Vol.8 No.3, Summer, 1977            | <input checked="" type="checkbox"/> Vol.11 No.1, Winter, 1980 |
| <input checked="" type="checkbox"/> Vol.5 No.1, Summer, 1974               | <input type="checkbox"/> Vol.8 No.4, Autumn, 1977            | <input checked="" type="checkbox"/> Vol.11 No.2, Spring, 1980 |
| <input type="checkbox"/> Vol.6 No.1, Spring, 1975                          | <input type="checkbox"/> Vol.9 No.1, Winter, 1978            | <input type="checkbox"/> Vol.11 No.3, Summer, 1980            |
| <input checked="" type="checkbox"/> Vol.6 No.2, Autumn, 1975               | <input type="checkbox"/> Vol.9 No.2, Spring, 1978            | <input type="checkbox"/> Vol.11 No.4, Autumn, 1980            |
| <input type="checkbox"/> Vol.7 No.1, Winter, 1976                          | <input checked="" type="checkbox"/> Vol.9 No.3, Summer, 1978 | <b>★ : Indicates issues out of stock.</b>                     |
| <input type="checkbox"/> Abstract and Index, 1971-80 (Special Issue, 1983) |                                                              |                                                               |

(Check issues and number of copies you wish to order)

Back Issues from 1981, ¥1,700 per copy (Vol.12, No.1 and No.4 are out of stock)

**Abstract and Index, Special Issue, 1983, ¥2,000 per copy.**

Vol. \_\_\_\_\_ No. \_\_\_\_\_, \_\_\_\_\_ copy / copies

(Check one)

Please invoice me/us

I/We enclose remittance for ¥ \_\_\_\_\_

\*\*\*\*\*

Name: \_\_\_\_\_

Firm: \_\_\_\_\_

Position: \_\_\_\_\_

Address: \_\_\_\_\_

(block letters)

**FARM MACHINERY INDUSTRIAL RESEARCH CORP.**  
2-7-22 Kanda-Nishikicho, Chiyoda-ku, Tokyo 101-0054, Japan  
Tel. (03)-3291-3674

---

---

---

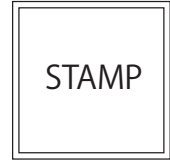

FARM MACHINERY INDUSTRIAL RESEARCH CORP.  
2-7-22 Kanda Nishikicho, Chiyoda-ku,  
Tokyo 101-0054, Japan

..... 1<sup>st</sup> FOLD HERE .....

..... 2<sup>nd</sup> FOLD HERE .....